

Application of cellulose derivates as coating in development of green packaging solutions

Požgajčić, Valentina

Master's thesis / Diplomski rad

2020

Degree Grantor / Ustanova koja je dodijelila akademski / stručni stupanj: **University of Zagreb, Faculty of Graphic Arts / Sveučilište u Zagrebu, Grafički fakultet**

Permanent link / Trajna poveznica: <https://um.nsk.hr/um:nbn:hr:216:748496>

Rights / Prava: [In copyright](#) / [Zaštićeno autorskim pravom.](#)

Download date / Datum preuzimanja: **2024-10-02**



Repository / Repozitorij:

[Faculty of Graphic Arts Repository](#)



UNIVERSITY OF ZAGREB
FACULTY OF GRAPHIC ARTS

VALENTINA POŽGAJČIĆ

APPLICATION OF CELLULOSE DERIVATES AS
COATING IN DEVELOPMENT OF GREEN
PACKAGING SOLUTIONS

MASTER THESIS

Zagreb, 2020



University of Zagreb
Faculty of Graphic Arts

VALENTINA POŽGAJČIĆ

APPLICATION OF CELLULOSE DERIVATES AS
COATING IN DEVELOPMENT OF GREEN
PACKAGING SOLUTIONS

MASTER THESIS

Mentor:
izv. prof. Branka Lozo, PhD

Student:
Valentina Požgajčić

Zagreb, 2020.

ACKNOWLEDGMENTS

I would like to thank prof. Branka Lozo for her trust and support while I was writing my master thesis. Also, a big thank you to Dr. Arie Hooimeijer for offering me a graduate internship at the Kenniscentrum Papier en Karton. It was one great opportunity to expand my academic knowledge and gain new experience while staying in the Netherlands. Thank you to all my colleagues at KCPK for their assistance during my stay in Arnhem. Thank you to Dr. Wilco De Groot, MBA for letting me do my research at IGT Testing Systems, Ferry Zuiderwijk and other employees for valuable advice and comments.

Lastly, I would like to thank my family for the support and encouragement they have given me throughout my life abroad and writing of my thesis.

ABSTRACT

Packaging nowadays consists mostly of polypropylene (PP). Plastic made from PP is the major water and soil pollutant, since it takes a lot of time to break down, unless it is burned or recycled. Nowadays we turn to natural packaging materials. Nanocellulose and microcellulose that originate from the plants are such natural and eco-friendly materials. Cellulose is a linear biopolymer naturally found in plant cells such as wood, cotton and linen. Its fibres are translated by mechanical or chemical processing into cellulose micro / nanofibrils (MFC / NFC) or cellulose micro / nanocrystals (MCC / NCC). The application of coating will be carried out at the laboratory level in the form of preliminary tests for use in the paper production. Also, papers coated with nanocellulose and microcellulose will be tested for surface characteristics and printability to see if they can compete with polypropylene plastic packaging. This research will allow for the food packaging industry as well as graphic industry to go green in their production process.

KEY WORDS

Nanocellulose, microcellulose, coating, paper, surface characteristics, printability

SAŽETAK

Pakiranje se danas većinom sastoji od polipropilena (PP). Plastika izrađena od PP je glavni zagađivač vode i tla, jer je potrebno puno vremena da se razgradi, osim ako se ne spali ili reciklira. Ovo je vrijeme kada se okrećemo prirodnim materijalima za pakiranje. Jedan takav materijal su nanoceluloza i mikroceluloza koje potječu iz biljaka. Celuloza je linearni biopolimer koji se prirodno nalazi u biljnim stanicama poput drveta, pamuka i lana. Vlakna se mehaničkim ili kemijskim preradom prevode u mikro / nanofibril celuloze (MFC / NFC) ili mikro / nanokristale celuloze (MCC / MCC). Primjena premaza provest će se na laboratorijskoj razini u obliku preliminarnih testova za uporabu u proizvodnji papira. Papiri premazani nanocelulozom i mikrocelulozom testirat će se na površinske karakteristike i mogućnost otiska kako bi se utvrdilo može li se natjecati s plastičnom ambalažom od polipropilena. Ovo će istraživanje omogućiti industriji ambalaže hrane kao i grafičkoj industriji da postanu zeleni u svom proizvodnom procesu.

KLJUČNE RIJEČI

Nanoceluloza, mikroceluloza, premaz, papir, površinske karakteristike, mogućnost tiskanja

TABLE OF CONTENTS

1. INTRODUCTION.....	1
2. THEORETICAL PART.....	2
2.1. The history of papermaking.....	2
2.2. Paper production technology.....	4
2.2.1. Fibre production.....	4
2.2.2. Paper production.....	6
2.2.2.1. Pulp preparation.....	6
2.2.2.2. Paper machine.....	7
2.2.2.3. Paper finishing.....	9
2.2.3. Physical properties of paper.....	11
2.3. Paper coating.....	13
2.3.1. Coating composition.....	14
2.3.1.1. Pigments.....	14
2.3.1.2. Binders.....	15
2.3.1.3. Additives.....	16
2.3.2. Coating production.....	18
2.3.3. Production of cellulose nano- and micro- crystals.....	19
2.3.3.1. Cellulose nanocrystals.....	19
2.3.3.2. Cellulose microcrystals.....	21
2.4. Coating process.....	23
2.4.1. On-line and off-line coating machine.....	23
2.4.2. Spray coating.....	23
2.4.3. Curtain coating.....	25
2.4.4. Blade coating techniques.....	28
2.4.5. Printing technology used for the application of coating.....	30
2.5. Drying of coating.....	31
2.5.1. Infrared drying.....	32
2.5.2. Convection (hot air) drying.....	32
2.5.3. Cylinder (contact) drying.....	34
3. EXPERIMENTAL PART.....	35
3.1. Research plan.....	35

3.2. Materials and equipment.....	36
3.2.1. Paper substrate.....	36
3.2.2. Paper coating.....	36
3.2.3. Laboratory test equipment.....	36
3.3. Testing methods for surface characteristics.....	39
3.3.1. Air permeability Bendsten.....	39
3.3.2. Size-o-scope.....	40
3.4. Printability testing methods.....	42
3.4.1. Print penetration (oil absorption).....	42
3.4.2. Set off (0.7 m/s).....	44
3.4.3. Colour/density/transfer (aluminium printing disc).....	47
3.4.4. Wet pick / wet repellence (rubber 85 Shore A).....	49
4. RESULTS AND DISCUSSION.....	54
4.1. Testing methods for surface characteristics.....	54
4.1.1. Air permeability Bendsten.....	54
4.1.2. Size-o-scope.....	55
4.2. Printability testing methods.....	58
4.2.1. Print penetration (oil absorption).....	58
4.2.2. Set off (0.7 m/s).....	60
4.2.3. Colour/density/transfer (aluminium printing disc).....	62
4.2.4. Wet pick / wet repellence (rubber 85 Shore A).....	63
5. CONCLUSION.....	69
6. REFERENCES.....	71
7. APPENDICES.....	74

1. INTRODUCTION

The rising concern about the environment is pushing the graphic industry to turn towards the use of print materials that come from renewable resources and are easily recyclable. The sustainable development in the graphic industry is promoted by the green and lean printing.

The main objective of this thesis is to investigate the barrier properties of bio-based materials. The bio-based materials selected for evaluation in the research are laboratory prepared cellulose nanocrystal and microcrystal coatings. This thesis will look into application processes used for coating and printing, as well as their technical performance and correlation with each other. Materials will be examined and compared in terms of surface characteristics and printability.

The aim of the thesis is to investigate whether paper coated with biobased coating in the form of nanocellulose and microcellulose can replace packaging made of polypropylene that lasts longer than the product itself. It will look into how to apply nanocellulose coating and how it will behave after drying. Also, paper coated with nanocellulose and microcellulose will be tested for surface characteristics by means of air permeability tests and printability tests to see if desired results have been reached. This research will allow for the food packaging industry as well as graphic industry to go green in their production process.

Novel types of coatings that are included in the research deal with the same question: “Do they provide the same quality as conventionally used materials? Can they eventually replace the polypropylene packaging?”

Laboratory prepared cellulose nanocrystal and microcrystal coatings will be examined for their printability features with an interest in possible application in the graphic industry.

2. THEORETICAL PART

2.1. The history of papermaking

Ancient civilizations, from Sumerian, Babylonian and Persian, and even Egyptian, used clay tiles for writing, more precisely engraving. In addition to stone and clay tiles, the Egyptians also used papyrus, which they made from the marsh plant *Cyperus papyrus*. In the 2nd century BC parchment started to be made in the Middle East and eventually replaced papyrus. Parchment is actually thinly prepared sheepskin. It had very good properties, such as strength and durability and it was convenient for writing. The use of parchment remained in Europe until the invention of the printing press.[1]

The first real paper appeared in China 105 BC and the invention was linked to the Chinese Minister of Agriculture T'sai Lun. The Chinese used silkworm shawls, bamboo, rice straw, hemp, flax and other plants. The material was crushed or ground in stone vessels using wooden batons with addition of old rags and fishing nets. Water and lime were added to make a slurry, which was then poured onto a square sieve. After squeezing a sheet of paper well, it was removed from the screen and dried on flat boards. The sheets of paper were then stacked, pressed, coated, and dried again. On smooth stone slabs, they ironed paper with ivory to produce smooth and glossy paper suitable for writing. After China, paper production was developed in Korea and Japan in the 7th century and slowly began to spread across Asia to Europe. [1]

Since Gutenberg's invention of the printing press, accelerated paper production has begun. In the 18th century, a mill was constructed in the Netherlands to provide greater production capacity, improve the preparation of raw materials and facilitate operation. The mill was called *the Dutch (holandez)* and has remained in the paper industry to this day with numerous structural improvements. [1]

In 1799 the Frenchman Louis Robert constructed a machine consisting of an endless sieve strip sandwiched between two wooden rollers. The sieve was movable and in front of it there was a paddle pump, which, from a large vessel filled with a diluted

suspension of ground fibres, threw the suspension on the sieve. When the sieve was moving, it formed a wet strip of paper that was carefully removed and dried. The sieve was 3.4 m long and 0.64 m wide. This paper machine was the forerunner of today's paper machines. What followed was the ever-evolving development of paper-making machines. This development resulted in a shortage of raw materials. Consequently, new technologies for the production of pulp from wood were developed. In the mid-19th century technological processes for the production of wood pulp were discovered, followed by various processes for the production of cellulose. [1]

2.2. Paper production technology

2.2.1 Fibre production

For over one hundred years wood has been the most important raw material for chemical and groundwood pulp for paper production. Figure 1 gives an overview of the raw materials and fibres required to produce paper, card, and board. Wood is mechanically and/or chemically prepared for paper production.

Raw materials	Wood		Annual plants (straw, reed, cotton, etc.)	Rags (linen, hemp, etc.)	Waste paper	Fillers (kaolin, calcium carbonate, tita- niumdioxide, etc.)
Processing	log	mechanical shavings	chemical shavings	chemical	chemical/ mechanical	recycling process
Fiber product	groundwood pulp	refiner pulp	chemical pulp		pure cellulose fiber	recycled fiber
	primary fiber					secondary fiber
End products with dominant proportion of fiber	newsprint, magazine paper, folding box card/board, writing/printing paper (medium fine paper and paper containing wood)		writing paper, printing paper (coated, uncoated), sack paper (woodfree paper)		banknote paper, document paper, magazine printing paper, bank paper	newsprint, simple boards, folding box card (proportion of filler up to 30%)

Figure 1 – Raw material and fibres used in paper production

(Kipphan, H. (2000). Handbook of print media Technologies and production methods, Heidelberg, pg.118)

Mechanical groundwood pulp is processed out of wood that was mechanically treated by grinding. Refiner groundwood is obtained by grinding chips that is a waste product of timber mills. *Chemical pulp* is the fibre material obtained from wood (chips) and other vegetable raw materials (e.g., annuals including hemp, jute, esparto, straw, cotton) by chemical digestion. [2]

Groundwood pulp differs from the chemical pulp mainly in the fibre characteristics, since chemical pulp has not only more fibres, which are firmer and suppler, but also a higher degree of whiteness. Depending on the chemical solution used for treating the

fibres there is sulphate pulp made with alkaline process and sulphite pulp made with acidic process. Approximately 85% of the chemical pulp produced worldwide is sulphate pulp, because it is firmer than the sulphite pulp, but has a lower degree of whiteness and is produced with a lower yield. [2]

Groundwood pulp and *chemical pulp* fibres are referred to as primary fibres. Besides that, waste paper has always played an important part in paper production. Today, paper is manufactured using up to 60% of waste paper in its production. However, the use of these recycled fibres obtained from waste paper is limited. In the process of obtaining secondary fibres from waste paper, a work-intensive cleaning process and suspension, as well as deinking i.e. removing the printing ink, and fractionating i.e. structuring according to fibre lengths are required. In addition, it must be noted that there are limits to the reuse of waste paper fibres. The fibres are unusable after having been recycled 3–5 times. [2]

Semi-chemical pulp presents the combination of mechanical and chemical preparation, mostly by removing lignin in the solution of sodium sulphite in a neutral pH range. This process gives yield of 60 – 90 %, but the amount of remained lignin is higher than in the chemical pulping process. [3]

The unbleached sulphate pulp can be used to make certain types of paper even without additional bleaching. Such pulp is called kraft pulp and is most commonly used for the production of packaging materials with good mechanical properties. The colour of the pulp does not pose a problem, since its primary purpose is not related to printing.[4]

The bleaching process of paper pulp was usually done with chlorine, but because of environmental reasons bleaching is nowadays carried out by oxidation, peroxide or ozone. Depending on the fibre type used, remained lignin can be later removed in some of the following chlorine-free bleaching processes. The recycled fibre is unbleached or bleached with non-chlorine compounds such as oxygen, ozone or hydrogen peroxide (*Process Chlorine Free (PCF)*). The virgin fibre is bleached without elemental chlorine

or chlorine compounds such as oxygen, ozone or hydrogen peroxide (*Totally Chlorine Free (TCF)*). The last process uses chlorine derivative, usually chlorine dioxide instead of elemental chlorine to bleach virgin recycled fibres (*Elemental Chlorine Free (ECF)*).[3]

Paper additives are added during the paper production work to achieve the desired properties of the future paper, according to its purpose. The most important groups of supplements are fillers, binders and dyes, although there are other supplements. These additives may be added to paper during paper mass production, but sometimes applied to finished paper in the form of a surface coating.

2.2.2. Paper production

2.2.2.1. Pulp preparation

Preparation of the material before the pulp suspension is inserted into the paper-making machine involves the preparation of pulp, additives and auxiliaries. This includes the treatment of pulp milling and the supply of fillers (usually kaolin and calcium carbonate) and additives, which determine the basic properties and quality characteristics of the paper. The final composition of the pulp is contained in the so-called paper container, which also supplies the necessary fillers and additives.[2]

Fillers are low soluble inorganic pigments of white colour, carbonates, silicates, sulphates, oxides and sulphides. They are added for several reasons, such as increasing the paper weight, increasing the opacity and the degree of whiteness, softness and bulk density of the sheet, or the smoothness of the surface. Fillers have non-hygroscopic feature and due to that partly affect the dimensional stability of the paper. These negative phenomena can almost be completely cancelled by paper coating. [2]

Binders are hydrophobic additives to paper, most commonly natural or artificial resins, which are added in weight or surface in the form of coatings, with the aim of reducing the paper's absorbency and porosity and making sheet surface homogeneous.

Other paper additives can be dyes, optical whiteness and some special additives, such as fungicides, preservatives etc. [2]

2.2.2.2. Paper machine

Production of paper and card mainly takes place on modern high-speed paper machines today. Machines for producing higher paper quality are available for working widths of 6.60 m and above, and speeds of 1300 m/min (21.7 m/sec). [2]

Paper machines are at the heart of every paper mill. The fourdrinier paper machines with endless wire are the most widespread. Figure 2 shows the production of newsprint with the following machine components (for other types of paper, additional components must be supplied according to the requirements):

- headbox,
- wire section,
- press section,
- dryer section,
- calender,
- winding unit with longitudinal slitting.

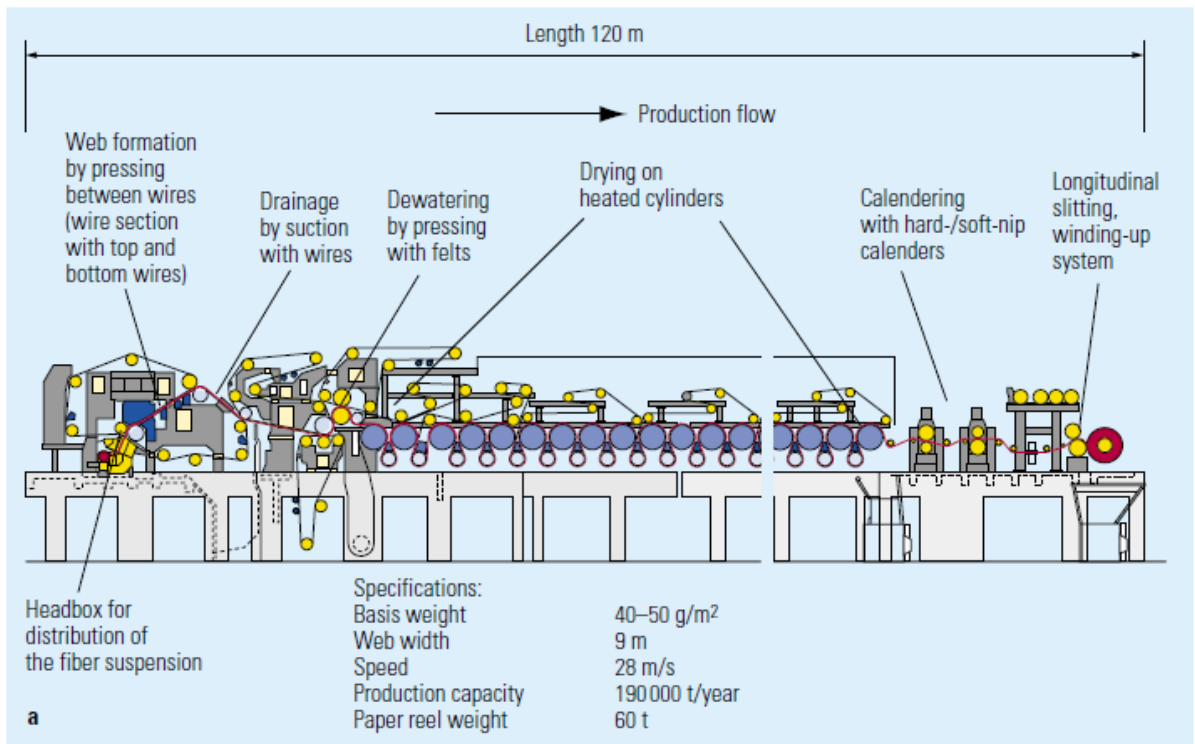

Figure 2 – The fastest paper machine for the production of newsprint in 1997, example of a fourdrinier paper machine (Voith Sulzer Paper Technology, Germany, 1997). -

Diagram showing production stages

(Kipphan, H. (2000). Handbook of print media Technologies and production methods, Heidelberg, pg. 120)

The pulp is routed through the headbox to the endless wire, where the paper web is formed by draining (filtration). The water flows off through the wire due to gravity. The fibres remain on the wire and are felted into a continuous web. This process is referred to as “drainage.” With a slight jogging motion exerted on the wire, the longitudinal orientation of the fibres becomes parallel to the direction of the flow, which causes the characteristic grain direction of the paper and slowly reduces and supports the draining and felting. Sheet paper is cut out from the web material. There is a difference between the long grain sheets, which have fibre orientation parallel to the length side and short grain sheets, which have fibre orientation parallel to the narrow side of a sheet. The fibre direction of the completed paper is important for a lot of printing work in view of the stability of the paper, as fibres expand more in width than in length when moistened.

[2]

Paper has greater stiffness and strength in the direction of fibre than across it. The screen mesh cylinder running on the fourdrinier wire (dandy roll) evenly forms the upper side of the wet web. The embossed or soldered marks on the dandy roll wire leave an impression – watermarks – while rotating into the wet web. Elevations result in light watermarks, and sinks (from compaction of pulp) in dark watermarks, also referred to as “light shade watermarks”. This is followed by wet pressing, where at the end of the wire section over the couch press the still wet paper web is moved into the so-called press section. This is where further mechanical draining and compaction of the paper web takes place. The next step the paper web undergoes is a long, gentle drying process against drying cylinders heated by steam. The type of drying has an effect on the strength of the paper and how the paper stretches. Along the line of the dryer section there is a size press, where surface sizing, which increases the wet-strength or light pigmentation (colouring) of the paper web, takes place. [2]

Modern size presses, *film presses*, provide a precise dosage of the volume of coating. The calender is part of the end section of a paper machine and it mechanically evens out or reduces slight irregularities and the roughness of the paper. The drying section is followed by a cooling system, which is used for cooling the paper web before winding it onto a steel core, i.e. a reel drum. [2]

2.2.2.3. *Paper finishing*

Frequently used processes for paper finishing are: coating, impregnating, parchmentizing and laminating. One of the important finishing processes for paper is coating. It consists of machine coating of a base paper with one or several layers of a white pigment coating that consists of: pigments, binders and additives (e.g. optical additives). [2]

The function of the binders of a coating colour is to finely distribute pigments in the coating colour and to bind them to the paper. The paper coating can influence the paper surface regarding lightness/colour and structure/roughness. For example, it can produce glossy, half-matte (satin gloss) or matte surfaces for better printability. Printing results

can be achieved that are not possible on uncoated natural paper. The base paper is matched to the different requirements of the printing process through the composition of the coating material.

After coating the paper, calendering can take place to give the surface a satin finish. This way the paper obtains its final surface structure (gloss and glaze). Calendering takes place in a calender in which the paper web is mechanically routed between rollers that are located above one another under pressure, friction and warmth. Paper or card obtain special structures, i.e. fine and coarse or hammertone embossing in an embossing calender.

Today, such a large variety of coated and cast-coated paper of very different properties is available for use in all printing processes that it is hard to obtain an overview. With cast-coated paper the mirror finish surface is not produced by calendering, but after the coating by contact drying, which follows immediately against a hot chrome cylinder. In this way the coating undergoes plastic deformation and the surface structure of the extremely smooth chrome cylinder is transferred to the paper or card surface. [2]

2.2.3. *Physical properties of paper*

Paper's behaviour in printing process is affected by paper's dimensional and surface properties and its strength. The type of fibre, and its treatment during the papermaking process, as well as the finishing process, influences the printability and runnability properties.

Dimensional properties of paper are defined by the grammage, thickness and bulk, where thickness is usually proportionally related to the grammage, a weight per unit area, while the bulk is a volume of occupied mass of the paper.

Surface properties of paper are specified by the smoothness, porosity, absorption, rub resistance, surface strength, surface tension, moisture content and pH. Surface smoothness can be measured by the air leakage rate. Porosity is defined as the air permeability of the paper that determines absorption ratio of the paper surface. Absorption is determined by the Cobb test. This test determines the amount of water absorbed into the surface by a sized (non-bibulous) paper in a set period of time, usually 60 or 180 seconds (Cobb60 or Cobb180). Water absorbency is measured in g/m². [7]. Rub or abrasion resistance is visible by the loose fibres and dust on the paper surface. Surface strength is a measure of resistance to picking or delamination, caused by the low internal bond strength. Surface tension of substrate determines acceptance of ink and can be measured by the contact angle of liquid on the paper surface. Moisture content influences dimensional stability of paper and drying time of ink. [4]

Visual appearance of paper is specified by the colour, whiteness, brightness, tint, gloss, opacity and fluorescence. Paper colour is usually white or brown, depending on the bleaching process, if it is not additionally coloured. Brightness is a measurement of light reflected from the surface of the paper sheet in a specific wavelength of blue light, while the whiteness is determined by light reflectance across all wavelengths. Tint is related to the whiteness measurement and determines the colour shade of paper. Specular gloss of paper is defined by the amount of light reflected from the surface at the same angle as the angle of light striking it. Gloss of paper and paper board is measured at 75°, while gloss of printed and coated paper is measured at 60°. Opacity is

a property of paper that describes the amount of light which is transmitted through it. Paper that has a high degree of opacity does not let much light pass through it, while paper that has a low degree of opacity is more translucent, or allows much light to pass through it. [8] Fluorescence is used as an enhancement of brightness by using the paper additives that absorb in the UV spectrum and emit the blue part of the spectrum. [4]

2.3. PAPER COATING

Coating improves the printing properties of paper. In the coating of paper, aqueous suspension called coating colour is applied to one or both sides of paper. After application of the required amount, the coating is dried. [5]

Coating colour consists of several components: pigment, binder, thickener and water. Pigment is one of the most important components. Pigments are usually various minerals by their origin. Kaolin clay and calcium carbonate are the most common. There are also synthetic pigments. Pigment particles are very small, 0.5 – 1.5 μm in size. Binder is there to bind pigment particles to each other and to the base paper. They also control the coating colour viscosity and water retention. [5][6]

Binders can be synthetic and natural. Thickener can be added to modify the rheology and water retention of the coating colour into the increasing direction. It can also have good binding properties and then it is called co-binder. Thickeners can be fully synthetic or based on natural polymers. Water makes it possible to mix all the components of the coating colour. It is used to transport the colour elsewhere and apply it on the base paper so it is uniformly dispersed. Eventually water evaporates from the coating layer, which then consolidates. [5]

Coating applied on paper may have different effects on the properties of paper. Ink absorption and dusting decrease, whereas surface strength, as well as opacity, gloss and sometimes brightness increase. Mechanical strength and stiffness of paper decrease if compared with uncoated paper in the same basis weight.

Coating process can be divided into different phases:

1. Application of the coating colour onto the base paper
2. Metering of the coating - may take place before, during or after application
3. Drying of the coating
4. Finishing – supercalendering for paper, soft calendaring for boards

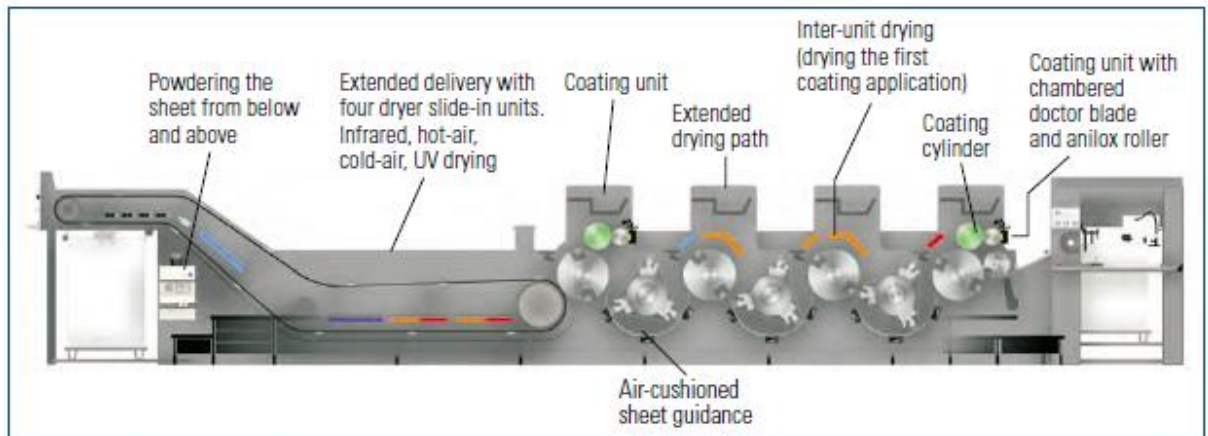

Figure 3 – Off-line surface finishing system (Speedmaster CD 102 LYYL, Heidelberg)
 (Kipphan, H. (2000). Handbook of print media Technologies and production methods, Heidelberg, pg.256)

2.3.1. Coating composition

2.3.1.1. Pigments

Pigments form 80 – 95% of coating by weight, and in volume fraction that is 70% of the solid material of the coating. Choosing pigment for coating means choosing certain properties for the coating. Different pigments gave different coatings.[6]

Properties of an ideal pigment would be: appropriate particle size and narrow particle size distribution, no impurities, good dispersibility, high chemical stability and low solubility in water, as well as compatibility with other components. Besides that, an ideal pigment would not need much binder and it would be cheaper.[5]

One way of classifying pigments is by the amount of relative dosage. Main pigments form the major part of the coating. Special pigments are similar to the main ones, except that their applications are limited. Additional pigments are often used as a way to improve the printing properties, such as optical properties, gloss and ink absorption. Main pigments include clay (kaolin), ground calcium carbonate (GCC) precipitated calcium carbonate (PCC) and talc. Special pigment is gypsum. Additional pigments are: plastic pigments, alumina trihydrates and titanium dioxides.[6]

Figure 4 shows physical properties of coating pigments for easier comparison of different pigments. Data is collected from various sources. [6]

Pigment	Chemical composition	Most particles, μm	Particle shape	Density, kg/dm^3	Refractive index	ISO-Brightness
Kaolin clay	$\text{Al}_2\text{O}_3 \cdot 2\text{SiO}_2 \cdot 2\text{H}_2\text{O}$	0.3–5	Hexagonal platy	2.58	1.56	80–90
GCC ^a	$\text{CaCO}_3, \text{MgCO}_3$ (2–3 %)	0.7–2	Cubic, prismatic, platy	2.7	1.56–1.65	87–97
Talcum	$\text{MgO} \cdot 4\text{SiO}_2 \cdot \text{H}_2\text{O}$	0.3–5	Platy	2.7	1.57	85–90
Gypsum	$\text{CaSO}_4 \cdot 2\text{H}_2\text{O}$	0.2–2	Roundish	2.3	1.52	92–94
Titanium dioxide - anatase	TiO_2	0.2–0.5	Rodlike	3.9	2.55	98–99
- rutile	TiO_2	0.2–0.5	Roundish	4.2	2.70	97–98
PCC ^b	CaCO_3	0.1–1.0	Variable, usually rodlike	2.7	1.59	96–99
Calcined kaolin	$\text{Al}_2\text{O}_3 \cdot 2\text{SiO}_2$	0.7 (median)	Aggregated plates	2.69	1.56	93
Plastic pigment - solid	Polystyrene most common	0.1–0.5	Spherical	1.05	1.59	93–94
- hollow		0.4–1.0	Spherical	0.6–0.9	1.59	93–94
ATH ^c	$\text{Al}(\text{OH})_3$	0.2–2	Platy	2.42	1.57	98–100

^a Ground calcium carbonate (calcite), ^b Precipitated calcium carbonate, ^c Alumina trihydrate

Figure 4 - physical properties of coating pigments

(Liehtinen, E. (2006). Papermaking science and technology, Pigment coating and surface sizing of paper, Coating pigments – general, pg.64)

Pigments can be delivered to paper factories as slurries, dispersions with 60-78% solids or as powder.

2.3.1.2. Binders

By the amount of binder added, there are main binder, co-binder and sole-binder. Sole-binder is a single binder that has all desired functions of the binder in coating. Main binder and co-binder are added together and they have different functions. Main binder has binding function and co-binder affects rheology and water retention properties of the coating. [6]

Binders are also classified by their origin and solubility in water. There are synthetic binders that are not soluble in water, such as latexes (SB latex, acrylate latex, PVAc latex) and natural binders that are soluble in water. They are derivatives of natural polymers (starches, proteins, cellulose derivatives, carboxyl methyl cellulose (CMC)) and fully synthetic polyvinyl alcohol (PVA, PVOH). Natural binders are often multifunctional and can contribute to the bond strength and water retention and also improve runnability.[5]

Binders are added for several purposes: binding pigment particles to base paper (A), binding pigment particles to each other (B), partly filling the spaces between the pigment particles (C) and affecting viscosity and water retention of the coating colour, as seen in Figure 5 below. [6]

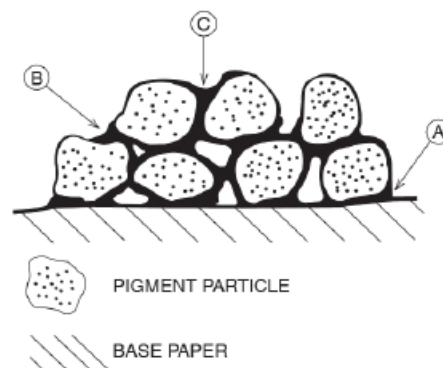

Figure 5 – functions of a binder in the coating layer

(Liehtinen, E. (2006). Papermaking science and technology, Pigment coating and surface sizing of paper, Coating pigments – general, pg.65)

2.3.1.3. Additives

Coating additives are a heterogeneous group of coating colour component substances that fulfil various functions in coating colours or layers. They can be production additives, needed for the coating process, or product additives that affect specific paper properties. [5][6]

Dispersants, foam control agents, pH control agents, water retention and rheology modifiers, colorants, lubricants, preservatives are production additives. Product additives are optical brightening agents (OBA) and insolubilizers (or crosslinkers). [5]

Dispersant is a substance added to a suspension, usually a colloid, to promote dispersion and to maintain dispersed particles in suspension from settling or clumping. *Foam control agents* are added to prevent formation of foam in paper coating created by turbulent flow, since the presence of foam can influence the flow behaviour and/or viscosity of the coating. In the dried coating layer, foam can cause surface defects (pinholes, craters, streaks) with possible effects on ink absorbency and liquid and thus penetration. *Water retention, rheology modifiers and pH control agents* are used to improve the runnability of the coating. *Lubricants* have multiple functions. First, they improve the runnability of the coating process by reducing friction between the machine and the coating colour and between the base paper and the coating unit. They also enhance plastic deformation of the dry coating in the supercalender, where they prevent cracks in the soluble binder film. During calendering lubricants migrate from the coating and form a monolayer on the calender rolls and prevent the coating from sticking to the rolls. The coating process uses various chemicals in combination with lukewarm water and pH, resulting in an environment suitable for growth of microbes, which is way *preservatives* are added. [5]

Optical brightening agents are added because the brightness of pulp, fillers and coating pigments are not high enough to reach the set brightness levels. *Insolubilizers* are substances with the function to increase water resistance. When they are crosslinked with the soluble binders, or build an insoluble net around binders, they can decrease the water sensitivity of the paper. [6]

2.3.2. Coating production

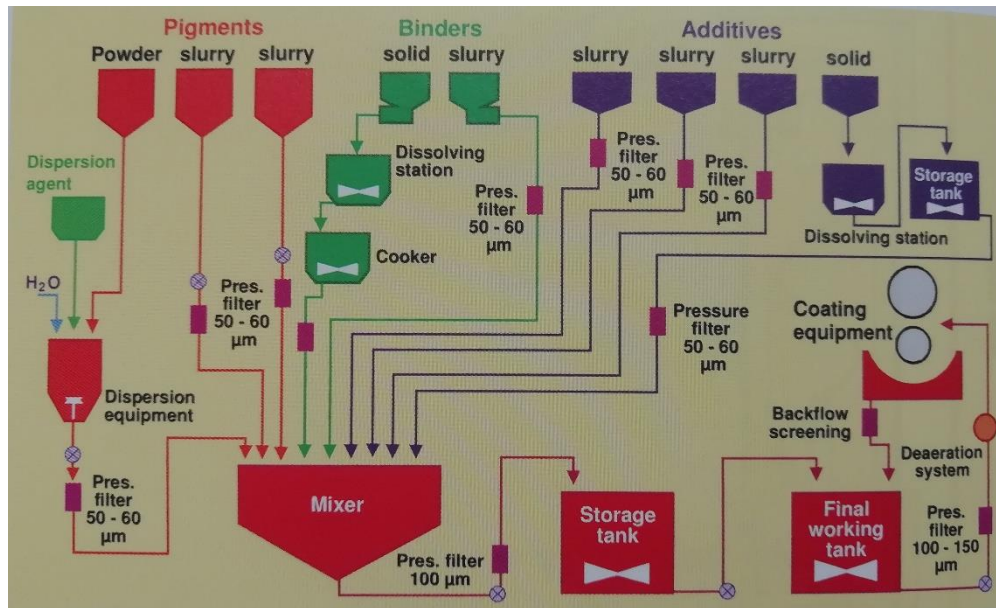

Figure 6 – Batch preparation of coating colours

(Holik H. (2006). Handbook of Paper and Board, WILEY-VCH Verlag GmbH & Co. KGaA, Weinheim, pg. 364)

All components needed for making the coating colour are transferred from the storage tanks through different recirculation pipes and filters to the mixer. The batch size and weight of components is measured precisely in the mixer that is placed on load cells or with mass flow meters and metering pumps. Figure 6 shows one such preparation of coating colours. Unlike batch preparation of coating colour, there is also continuous coating colour preparation. The main difference is that the components of coating colour are continuously pumped, screened and metered in the continuous mixer. In these mixers, mixing must be completed in a short time, while the components are passing through the mixer. This is shown in Figure 7. [5]

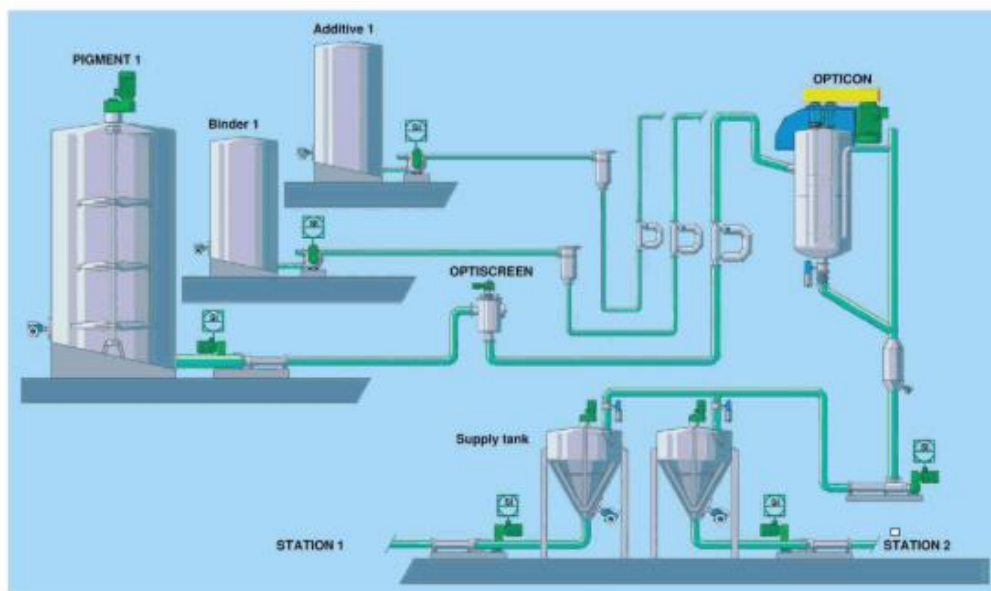

Figure 7 – Continuous preparation of coating colours

(Holik H. (2006). Handbook of Paper and Board, WILEY-VCH Verlag GmbH & Co. KGaA, Weinheim, pg. 365)

2.3.3. Production of cellulose nano- and micro- crystals

Cellulose is a very common polymer in plants, consisting of linked glucose molecules. It occurs naturally only in combination with other polymers, such as hemicelluloses and lignin. Chemically, cellulose is a combination of a whole group of molecules. Depending on the origin of the cellulose, the amount of glucose molecules in the polymer (i.e. the size of the cellulose molecules, degree of polymerization) can differ significantly. [4]

2.3.3.1. Cellulose nanocrystals

Nanocellulose (NC, sometimes NCC: nanocrystalline cellulose or CNC: cellulose nanocrystals) are cellulose crystals, but with a length in the order of 100 nm, and a diameter in the order of 10 nm. The exact size and ratio between the length and the diameter are highly dependent on the cellulose source and on the preparation.[9] From a molecular point of view, nanocellulose does not differ from "macrocellulose". In terms

of chemistry, however, the difference is very large: in general, chemical reactions take place on the surface of a crystal, and with a nanocrystal there are (relatively) more molecules on the surface of the crystal. This allows nanocellulose to enter into many more interactions with other molecules per gram of cellulose than regular cellulose. The usual way to produce nanocrystalline cellulose is by hydrolysis with acid. Alternative methods are hydrolysis with enzymes and TEMPO oxidation.[10] [11] As stated earlier, the different crystal forms each have different properties, and these properties determine their applicability in the final product.

A coating of a few micrometres (0.5 - 12 g / m²) can be applied to paper with conventional coating techniques. Coating that uses the 'size press' results in an inhomogeneous coating, possibly because the size press forces the coating into the paper, including water. Coating with a bar coater results in a homogeneous coating of a few micrometres in thickness. Coating using "spray coating" provides a homogeneous, thinner coating, but the high viscosity of nanocellulose requires either more dilution (resulting in more water in the paper) or keeping the coating solution in constant motion (because it is known that the viscosity of nanocellulose suspensions decreases with higher "shear" forces).[12]

To close the largest spaces between the fibres (saving more expensive nanocellulose) pre-coating or a second coating may be used over nanocellulose, to prevent problems with moisture swelling. Additional methods to improve the barrier effect are chemical modifications of the nanocellulose itself, so certain surface groups are introduced after synthesis to induce cross-linking of nanocellulose. [13] [14] [15] [16] [17]

Due to the filling of pores on the surface of the paper it smoothens the paper, strongly reduces permeability of oil and air, but only with a low relative humidity. [18] At high humidity, the barrier effect is lost due to the swelling of the fibre structure. It has limited influence on the strength of paper against mechanical forces.

2.3.3.2. Cellulose microcrystals

Micro crystalline cellulose (MCC) is a purified, partially depolymerized cellulose prepared by treating alpha cellulose (type I-b), obtained as a pulp from fibrous plant material with mineral acids. The particles size range is from 6 – 500 μm , depending on the production method used and the type of MCC produced. [19]

Both softwoods and hardwoods can be used. These woods have different chemical composition (proportions of cellulose, hemicelluloses and lignin) and structural organization. The amorphous regions are more prone to hydrolysis, so partial depolymerisation by acid hydrolysis results in shorter and more crystalline fragments, i.e., microcrystalline cellulose. Temperature, acid concentration and time affect the hydrolysis and leads to an exponential decrease in the number of glucose units $(\text{C}_6\text{H}_{10}\text{O}_5)_n$ in the cellulose chain, i.e. degree of polymerization (DP) decreases. The rate of hydrolysis slows to a certain level-off degree of polymerization (LODP). The LODP is a characteristic of a particular pulp and is typically found in the 200–300 range, 180–210 range for hardwood pulps and 210–250 for softwood pulps. One such process is reactive extrusion. [19]

The process for manufacturing microcrystalline cellulose using reactive extrusion involves two steps. In the first step of the process, the lignocellulosic material is extruded with a basic aqueous solution in order to destroy the lignocellulosic complex. The lignocellulosic complex is broken into lignin, hemicellulose and cellulose. The basic aqueous solution consists of sodium hydroxide, having a concentration ranging from about 4 to 12% (w/w), and the moisture content of the lignocellulosic material ranges from about 40% to 250% on a dry basis (db). Following extrusion, the lignin and hemicellulose are extracted with a basic solution, and the remaining cellulose is washed. The lignin and hemicellulose are extracted with a hot sodium hydroxide solution. The cellulose, which results from the extruded lignocellulosic material, can be bleached with hydrogen peroxide or sodium hypochloride, but it is not necessary before further processing it into microcrystalline cellulose. [20]

The second step of the invented process involves producing microcrystalline cellulose from cellulose by breaking a large cellulose molecule into smaller molecules.

If pure cellulose is used as the starting material, this is the only step necessary for the invented process. This step involves a hydrolysis reaction where an acid acts as a catalyst for the hydrolysis. An acid solution is sprayed or poured on a cellulose-containing material, and after that this acid-covered cellulose is fed through an extruder. Alternatively, cellulose and an acid solution are simultaneously fed into an extruder. The moisture content of the cellulosic material before extrusion ranges between about 40% to 250% on a dry basis (db). A strong acid such as hydrochloric acid, sulfuric acid, or nitric acid is used with concentration of about 1 to 5% (w/w). It is desirable to use sulfuric acid, since it is less corrosive than other strong acids, yet is still quite effective because of the aggressiveness of the extrusion process. This step can be accomplished in multiple steps, if desired. This involves feeding the cellulose through the extruder multiple times or feeding the cellulose through a sequence of extruders. [20]

After the extrusion, the microcrystalline cellulose product is neutralized, washed, bleached and dried. The excess acid from the hydrolysis reaction combines with the alkaline stream used to neutralize the product so that all of the waste from this process is neutralized before it is disposed. The alkaline stream is obtained from the basic solution used in breaking down the lignocellulose into cellulose and lignin. The microcrystalline cellulose is neutralized with sodium hydroxide. [20]

It has also been discovered that cellulosic raw materials, such as purified wood pulps with starting DP's of about 1100-1300, may be converted to LODP microcrystalline cellulose by the use of endo-cellulose type activities achieving LODP's in the range of 200-300. It has also been found out that this cellulose hydrolysis treatment yields highly crystalline materials in the order of 78% or higher by x-ray diffraction, which is the normal value for crystallinity or commercial MCC produced via acid hydrolysis. Enzymatic hydrolysis of cellulose to its highly crystalline breakdown product (MCC) in the present invention has advantages over prior methods such as acid hydrolysis, since the enzymatic process is a less drastic method of achieving LODP and can be carried out with less extreme pH conditions. [21]

2.4. Coating process

2.4.1. On-line and off-line coating machine

There are two ways of incorporating the coating machine and the calender into the papermaking line. One way is an on-line section of the paper machine and the other as separate off-line machines.

The differences between the on-line and the off-line coating machine are the following: the off-line coating machine is a more expensive investment and has more separate machines in the line, but finishing breaks, shut-downs and grade changes don't affect the work of the papermaking machine. On the other hand, the on-line coating machine is a less expensive investment, but when it breaks and has to be shut down, the papermaking machine must also be stopped. Figure 8 shows the off-line coating line. [6]

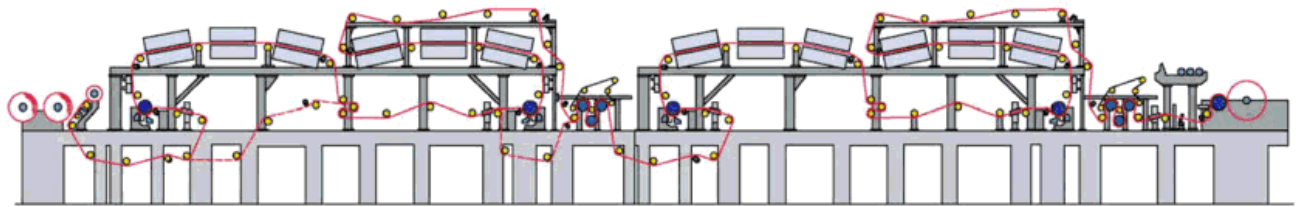

Figure 8 – Off-line coater

(Holik H. (2006). Handbook of Paper and Board, WILEY-VCH Verlag GmbH & Co. KGaA, Weinheim, pg. 374)

2.4.2. Spray coating

This method of the coating process is a non-contact method, which is based on controlled high-pressure spray application of coating directly onto the paper surface. Application nozzles are installed in a closed chamber and paper is led through the chamber. Such system has two separate rows of nozzles that ensure continuous spray, where one row is in operation mode and the other is in service position where it can be cleaned or changed. Figure 9 shows the two rows of nozzles in the coater. [6]



Figure 9– Spray nozzles in the coater

(Kettunen, H. (2006). Papermaking science and technology, Pigment coating and surface sizing of paper, Coating and surface sizing technologies, pg.527)

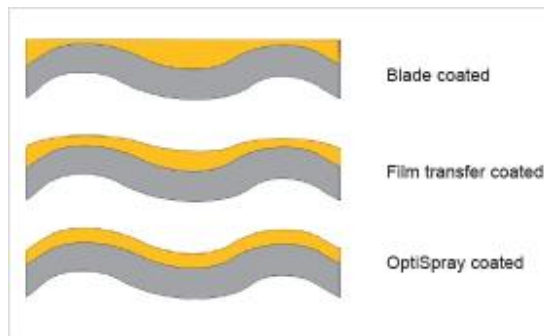

Figure 10 – Difference in coating layer between different coating techniques

(Kettunen, H. (2006). Papermaking science and technology, Pigment coating and surface sizing of paper, Coating and surface sizing technologies, pg.528)

Penetration of the coating colour into the base paper is limited, because the non-contact application has low impact pressure on the web of paper. Sprayed colour has droplet size of 20 – 40 μm . Mist that is generated while spraying is a key issue in this type of application, alongside the challenge of coating a web homogenously over its entire surface with a spray. This technology can be used for wide range of coating weights from 2 – 30 g/m^2 . Since it is non-contact application it has good runnability and machine can get speed up to 2500 m/min. [6]

2.4.3. Curtain coating

For this application process a thin free-falling film of the coating fluid (curtain) is formed. The paper passes through the curtain and is then coated. It is an old technique that is used in many fields of industry. In paper industry it was first used for coating photographic papers with light-sensitive chemical that had to be applied very homogeneously. This application is contact-free, which reduces the risk of web breaking and improves runnability. [5]

Curtain coaters are divided according to the curtain generating principle and the number of layers. Figure 11 shows a multi-layer slide die and a single-layer slot die. In a slide die, coating colour goes out from the nozzle on the top side onto inclined surface and then flows down and creates a free curtain. On the other hand, in slot die, coating colour goes out from the bottom side and the curtain falls down vertically. [6]

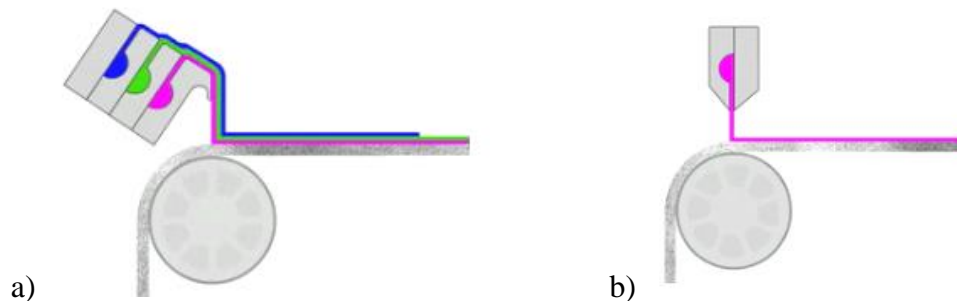

Figure 11 - a) multi-layer slide die; b) single-layer slot die

https://www.tse-coating.ch/?page_id=1007&lang=en

Homogeneity of the coating layer is determined by the homogeneity of the curtain. When mixing all components for coating, it can happen that some air is trapped inside. For traditional coating techniques, certain air content is tolerated, since the air will be “pushed out” by a blade or transfer nip. Curtain coating does not have such redistribution step. Trapped air bubbles can cause an uncoated spot in the coat layer. Solution for this problem is to de-aerate the coating colour. One such de-aerator works with vacuum. Figure 12 shows an example of a vacuum de-aerator. It works in the way

the liquid is fed from the top. A rotating disk distributes the liquid over the entire perimeter of the vessel. As the liquid passes a sieve, small droplets with large surface area are formed and are drained down the vessel's wall.[6]

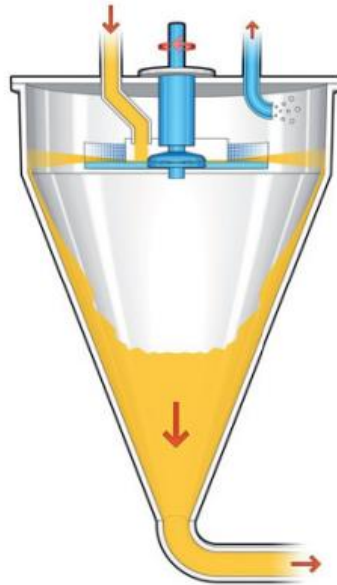

Figure 12 – example of a vacuum de-aerator

(Tietz, M. (2006). Papermaking science and technology, Pigment coating and surface sizing of paper, Coating and surface sizing technologies, pg.534)

There are different methods of application according to the TSE Troller Company. The Figures 13 – 15 show some of the applications.

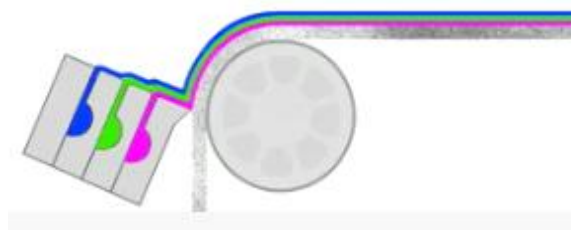

Figure 13 - Slide Bead Coating

https://www.tse-coating.ch/?page_id=1007&lang=en

Figure 13 shows a slide bead coating that has multilayer application, is extendible and vacuum controlled.

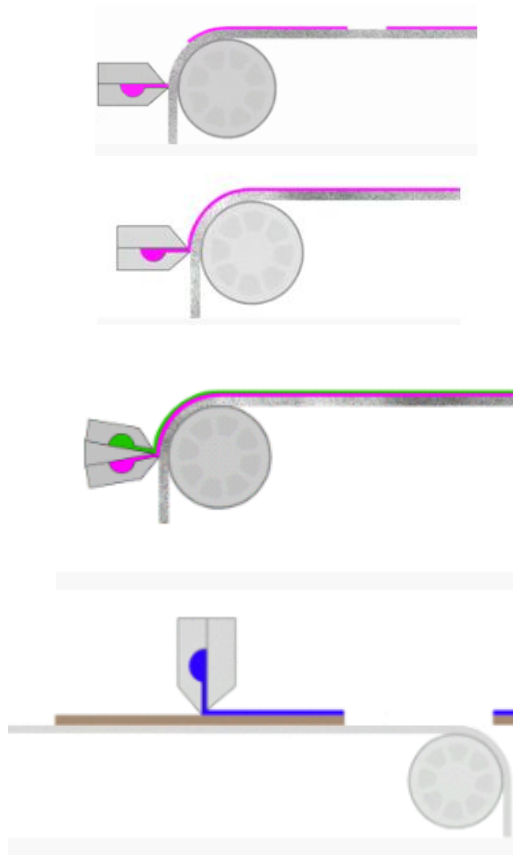

Figure 14 – Four types of slot bead coating
https://www.tse-coating.ch/?page_id=1007&lang=en

Figure 14 shows four types of slot bead coating that has broad application range. It is suitable for ultra-precise new application and is also vacuum controlled.

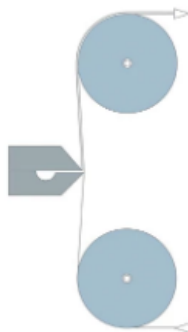

Figure 15 – Tension web coating
https://www.tse-coating.ch/?page_id=1007&lang=en

Figure 15 shows tensioned web coating that is good for thin layers at high speed and can be applied on both sides of the substrate before drying. Also, a high precision backing roll is not required.[6]

2.4.4. Blade coating techniques

Applicator roll coating stations are used on older coaters and are simple and robust devices that can reach coating application speed up to 1200 m/min. They work in a way that applies excess coating on the paper web from a coating pan with an applicator roll and then coating is metered to desired thickness with a doctor blade (Figure 16). The two rolls have different diameters and are covered with an elastic surface. The roll with larger diameter supports paper web and moves at the same speed as the paper. The smaller roll is the applicator roll and it runs slower than the paper web. [6]

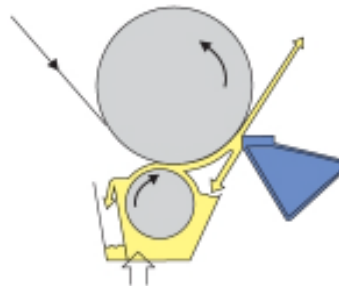

Figure 16 – Applicator roll coating station

(Linnonmaa, J., Trefz, M. (2006). Papermaking science and technology, Pigment coating and surface sizing of paper, Coating and surface sizing technologies, pg.472)

Jet applicator coating station uses a nozzle with slice opening of 0.6 – 2 mm and is located under the backing roll in the same position as the roll applicator (Figure 17). The distance of 5 – 20 mm between the nozzle lip and the backing roll allows for high speed application of the coating. Thickness of the jet is less than 1 mm and is a few centimetres long. The advantage is that it applies any coating without any film split pattern or overflow. The coating applied is very even and uniform and thinner than the coating when applicator roll is used. The final metering of the applied coating is done with a blade when most of the coating is removed and returned to the working tank. The

blade also applies pressure so that surface voids of the paper web are filled with coating.
[5]

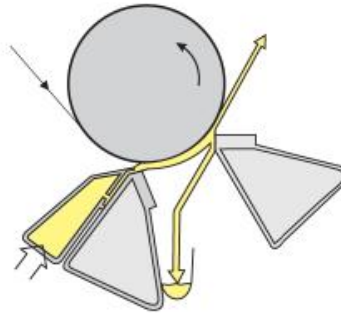

Figure 17 - Jet applicator coating station

(Linnonmaa, J., Trefz, M. (2006). Papermaking science and technology, Pigment coating and surface sizing of paper, Coating and surface sizing technologies, pg.475)

Short dwell time applicator (SDTA) is a coating station that consists of a closed chamber with coating feed and the metering blade (Figure 18). This shortens the dwell time between the coating colour and the paper before the metering. This principle is mainly used on fast LWC pigment coaters making rotogravure grades.[5]

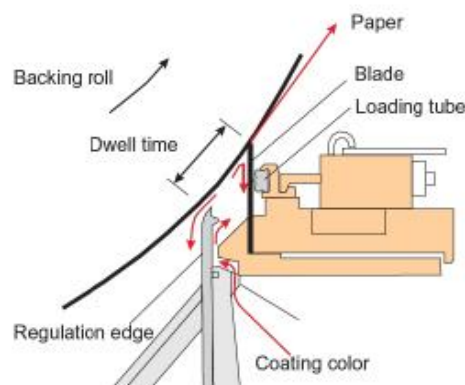

Figure 18 - Short dwell time applicator

(Linnonmaa, J., Trefz, M. (2006). Papermaking science and technology, Pigment coating and surface sizing of paper, Coating and surface sizing technologies, pg.474)

2.4.5. Printing technology used for the application of coating

Coating can also be applied by using printing techniques. One such technique is gravure printing. In gravure printing technology the image elements are engraved into the surface of the cylinder. The non-image areas are at original level. Prior to printing, the entire printing plate is inked and ink is then removed from the non-image parts with a blade before printing, so that ink remains only in the cells. The ink is transferred from the cells to the printing substrate by a high printing pressure and the adhesive forces between the printing substrate and the ink. The principle of gravure printing is illustrated in Figure 19. [2]

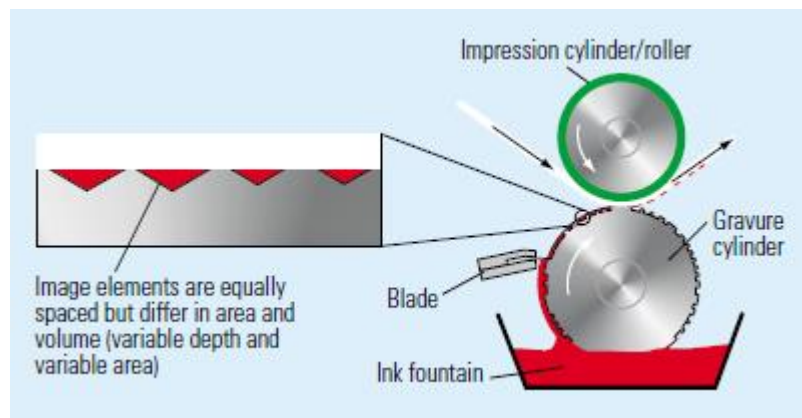

Figure 19 – Schematic diagram of gravure printing

(Kipphan, H. (2000). Handbook of print media Technologies and production methods, Heidelberg, pg.48)

Gravure printing plates are usually cylindrical. A special feature of industrial rotogravure printing is the fact that a whole cylinder (and no plate) is used for colour separation. This means that in a four-colour press four separate cylinders have to be changed for each new job. In multicolour gravure printing, drying must be carried out in between each printing unit, since wet-on-wet printing is not possible with low viscosity gravure printing inks, where typical viscosity is approximately 0.1 Pa·s. [2]

2.5. Drying of coating

Three commonly used drying methods are: IR drying (infrared radiation), convection (hot air) and cylinder (contact) drying. Each method can be used separately or in combination with each other. Some mills use combinations such as IR and cylinder combination or IR and air-drying combination.[6]

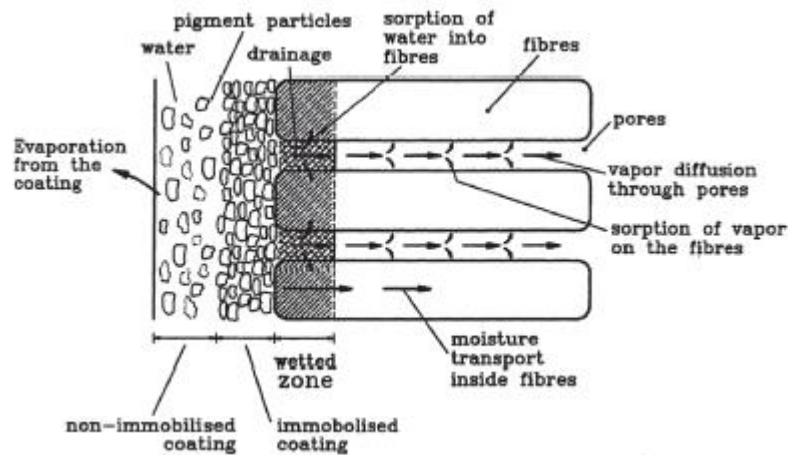

Figure 20 - Heat and mass transfer within coated web

(Heikkila, P., Rajala, P. (2006). Papermaking science and technology, Pigment coating and surface sizing of paper, Drying of paper coatings and drying equipment, pg.559)

In the initial phase of drying the coating is dewatered through evaporation and drainage of liquid into the base of paper (Figure 20). Solidification of the coating occurs as a deposition of pigment particles on the base web and a layer of immobilised coating is gradually built up. Water from the non-immobilised part is drained through that layer of immobilised coating, which was built up during the solidification of the coating. The drained water forms a wetted zone close to the coating/base interface. In case of pigment coating, solid material remains on the surface of the paper, while for the process of sizing or moistening solid material partly penetrates into the paper during the liquid drainage. [6]

2.5.1. Infrared drying

Infrared drying is a non-contact process that is suitable for pre-heating and initial drying of wet coating before drying it completely with the cylinders. It is also possible to direct the radiation to a limited area. IR dryers can be powered by electrical current and by gas. IR dryers powered by gas are cheaper and can reach higher temperatures, while the ones powered with electricity are easier to control and can be used for moisture profiling in the cross-machine direction. There are a few advantages and disadvantages of using IR dryers. [6][5]

The advantages of IR dryers are their small size, which makes it possible to install them next to the coating station, high effectiveness in crowded spaces and good controllability that helps with regulation of final moisture in paper. The disadvantages of such dryers are: high operating cost for electrical IR dryers and fire risks during web breaks. Also, high power density restricts the number of rows that can be used without quality problems and the available energy is limited. [5]

2.5.2. Convection (hot air) drying

Air flotation dryers blow hot air onto the paper surface. Air temperature can reach up to 350 °C or higher and air flow velocity can exceed 40 m/s. [50] Air dryers can be heated with in-line gas burners or steam coils. In steam dryers, temperatures are 170°C – 180°C with steam pressure of 10-15 bar. For gas-heated dryers, temperatures are between 300°C – 400°C. The drying speeds are 40 – 60 m/s, in some cases even higher.[6]

There are two types of air dryers – air flotation dryers and single-sided air impingement hoods. Figure 21 shows an air flotation dryer where the web is supported on both sides by air jets or air cushions. Two-sided air flotation dryers are used mainly in drying coated paper web, because they have good and stable web runnability for all speeds and grammages.[6]

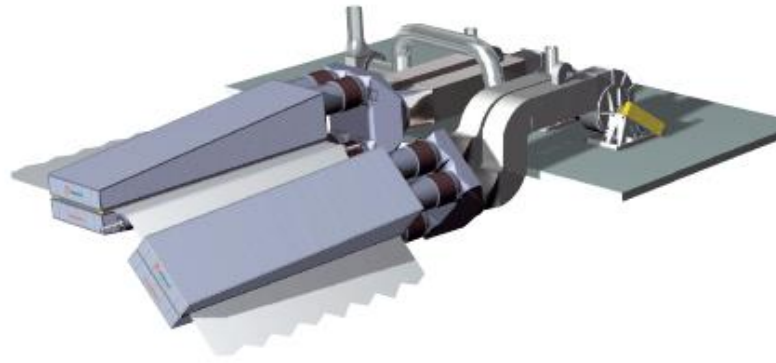

Figure 21 - air flotation dryer, two-sided

(Heikkila, P., Rajala, P. (2006). Papermaking science and technology, Pigment coating and surface sizing of paper, Drying of paper coatings and drying equipment, pg.565)

Figure 22 shows single-sided air impingement hood dryers that are good for drying only the coated side of the paper in cases of one-side coated papers. The web is supported on the opposite side with supporting rolls and can be supported by the nozzles.



Figure 22- single-sided air impingement hood, left - web supported by rolls, right - web supported by nozzles

(Heikkila, P., Rajala, P. (2006). Papermaking science and technology, Pigment coating and surface sizing of paper, Drying of paper coatings and drying equipment, pg.565)

There are two different air circulation systems – a blow-through and a draw-through system. The blow-through system has the main fan fitted before the heat source, whereas in the draw-through it is situated after the heat source. The two main advantages of the blow-through system in gas-heated dryers are:

1. the position of the main fan on the colder side of the burner, which means that it is not exposed to the heat.

2. the air volume flow is 25% higher after the burner, which means that a smaller fan that requires less power can be used. [6]

2.5.3. Cylinder (contact) drying

Cylinder drying can be applied after the coating layer has been immobilised and can withstand mechanical contact. That is why this is the last drying phase of coating. 2 to 6 cylinders are typically used in coating machines. For the double-sided film press coating the cylinder drying section can be longer, and if the coat weight is only a few g/m^2 per side, drying can be achieved only with the cylinders. [6]

While the paper is drying, the temperature of the paper is increasing so it needs to be cooled down before winding it on the roll. For that part of the process, there are 1 or 2 cooling cylinders at on the end of the cylinder drying section. Cold water is sprayed against the inside of the cylinder wall. Cooling the paper roll ensures higher quality of the finished product.

As the paper is drying, the temperature of the paper is increasing so it needs to be cooled down before winding on the roll. For that part of the process, on the end of the cylinder drying section, are 1 or 2 cooling cylinders. It uses cold water that is sprayed against the inside of the cylinder wall. Cooling the paper roll ensures higher quality of the finished product. [6]

3. EXPERIMENTAL PART

3.1. Research plan

The experimental part of the thesis was focused on the application of bio-based coating on a paper substrate. The bio-based coating was in form of MCC and NCC. The aim of the research was to investigate if this type of coating can have properties that are required for food packaging. As a result, these types of coatings on paper substrate has the possibility to replace packaging made of plastic, such as polypropylene, which lasts longer than the product itself.

The first task was to find a method for applying coating on a paper substrate. Spray coater device, which was used as the first option, turned out to be inadequate. The nozzles were not able to equally spray the coating content to the paper surface. Since the coating was applied only centrally, it was decided to try with another method. In the second attempt, the coating was applied by using an automatic film applicator. Application with this method turned out to be slightly better, but still not precise enough. Ultimately, it was decided to use an IGT Printability tester F1, which could print the coating by using a very precise anilox disc with a defined volume.

The printing of a coating was separated in two different groups that differ by a combination of printing materials, equipment and methods used:

GROUP G - in this group the application was done by using an IGT printability tester F1. A gravure printing method that uses a ceramic anilox disc of 24 ml/m² in volume and 80 lines per cm was used. The printing speed was set to 0.3 m/s, anilox force to 200 N and 2 pre-inking anilox revolutions. Testing was done on one paper substrate - BioLabel karton 200 g/m². Anilox was cleaned before each of the 5 layers printed. This allowed coating to progressively dry on the surface. Estimated coating thickness applied was cca 5.6 μm.

GROUP F - in the second group, the application was also done by using an IGT printability tester F1. A gravure printing method that uses the ceramic anilox of 24

ml/m² in volume and 80 lines per cm was used. Printing speed was set to 0.3 m/s, anilox force to 200N and 2 pre-inking anilox revolutions. Testing was done on one paper substrate - BioLabel karton 200 g/m². The difference between this group and the first group is the coating layer application method. Four layers were printed immediately one after the other, so the coating particles had sufficient time to form a better cohesion between the layers. This process was repeated one additional time after the samples had been left to dry for one day. Estimated coating thickness applied was cca 5.4 µm.

Each group was tested with 3 wt.% and 4 wt.% microcrystalline cellulose and with 4 wt.% nanocrystalline cellulose. 3 or 4 wt.% presents 3 or 4 grams of the powder or gel in 100 ml of demineralised water. Due to the lack of material used to make the coating, all tests were made with 3 to 4 samples.

3.2. Materials and equipment

3.2.1. Paper substrate

The paper substrate used was manufactured by Schut Papier B.V., Heelsum, The Netherlands: BioLabel karton 200 g/m².

3.2.2. Paper coating

Two types of cellulose coatings were used. The first type was cellulose hydrogen sulphate sodium salt (or Nanocrystalline Cellulose (NCC)) produced by *CelluForce* in Canada, with solid content of 8,5 % w/w and average particle size of 91.0 nm. The second type was a Microcellulose Abrocel P3500F powder with a particle size between 10 µm – 500 µm. MCC solution used was a 3 wt.% and a 4 wt.%, while the NCC was diluted to a 4 wt.%.

3.2.3. Laboratory test equipment

Preparation of MCC and NCC coatings was done at the Papiertuin laboratory (KCPK) at Schut Papier B.V., Heelsum, The Netherlands. A Snijders hotplate magnetic stirrer was used to heat water to approximately 38 °C. This higher temperature provided

a better dissolving of an MCC powder and an NCC gel. The powder was suspended into the demineralised water.

Application and printability tests were performed at the Testing Facilities at the IGT Testing Systems, Almere, the Netherlands, according to the standardised printability methods described in the W-leaflets provided by the IGT Testing Systems. The tests were performed using IGT printability testers and related auxiliary equipment listed.

Equipment used at IGT was:

- IGT Printability tester F1
- Anilox disc
- IGT AIC2-5
- IGT Amsterdam 6
- High speed inking unit
- IGT ink pipette, resolution 0.01 ml
- Printing disc, aluminium, 55 mm
- Printing disc with black rubber, 85 Shore A, pin, 50 mm
- Dampening disc for 0,5 µm of water
- Holder for the syringe
- Syringe Fortuna
- Testing liquid for print penetration, red
- IGT set off ink
- IGT pick test ink
- Stripes of reference paper, IGT C2846, 55 mm
- Techkon spectrodens, densitometer
- IGT Size-O-Scope
- Prüftinte nach DIN 53126, blau
- L&W Bendsten tester

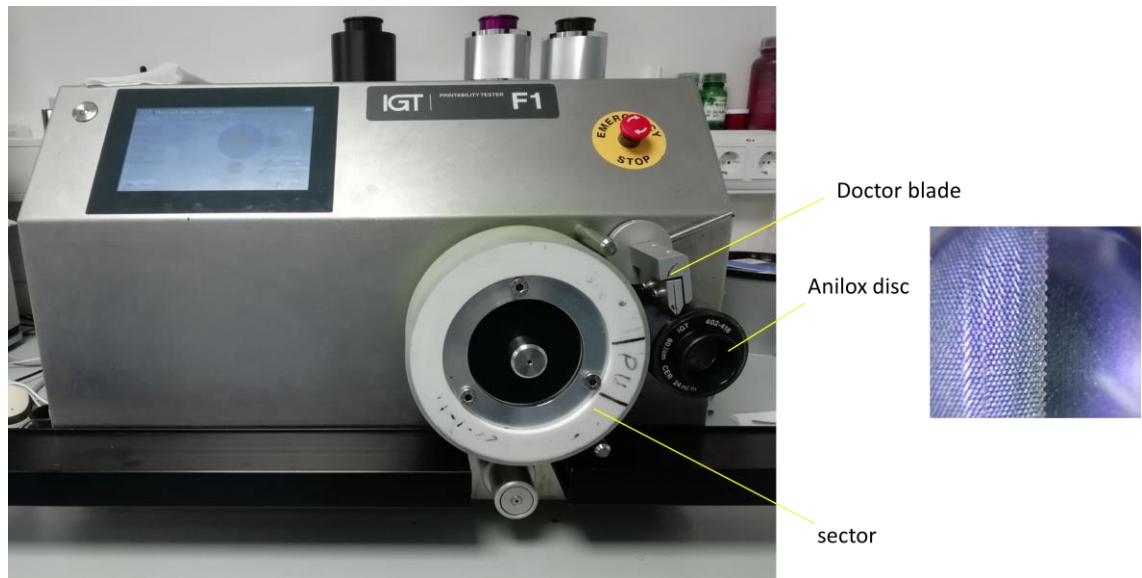

Figure 24 - IGT Printability tester F1 that was used for application process

More equipment details will be mentioned in the description of each test performed.

3.3. Testing methods for surface characteristics

3.3.1. Air permeability Bendsten

The air permeability (porosity) of a substrate indicates the amount of air that, as a result of a difference in air pressure on both sides, passes through a defined area of the substrate within set time. It is expressed in $\mu\text{m}/\text{Pa}\cdot\text{s}$ and/or in ml/min.

Figure 25 shows a Bendsten air permeability tester. Paper substrates were clamped between the measuring heads and a defined airflow was let through a defined area (10 cm^2) with a constant pressure of 1.45 kPa. The paper substrate was then kept on its place during an average of 5 seconds or until a difference in air pressure was detected. Results were presented in ml/min.



Figure 25 - L&W Bendsten tester

3.3.2. *Size-o-scope*

The IGT Size-O-scope determines the sizing of paper and board through the change in reflectivity. It can be used with watery liquids of all kinds. The whiteness decreases because of the show-through of the penetrating ink.[23]

The measuring started with a high contrast liquid getting in contact with the paper. The measured reflection started at 100 % and the penetration was visible as a reduction of the reflection. Factors influencing the reflection were brightness, colour and opacity of the paper. The penetration of the liquid was influenced by the sizing agent, sizing level and hence the hydroscopy of the paper, as well as the type of liquid used.

The test liquid that was contained in a closed container was pumped to the sample and it was flowing over the edge of the contact area. This guaranteed a continuous fresh flow of liquid, without pressure on the substrate. The measured area was illuminated by a uniform LED light source and the camera was measuring the reflection of the visible image. The measurements, graph of reflection in time and the actual image were recorded and stored. The data were exported for external analysis. [23]

Wood fibres and cellulose fibres are hydroscopic, so paper made of these fibres can easily be wetted. In many cases the paper has to be made as more water repellent to be writeable or printable. To reach this, a papermaker adds a sizing agent, rosin, AKD or ASA, to the paper stock. For surface sizing a starch is applied on the surface of the paper in the size press at the end of the paper machine before the last dryer section and the calender. Surface sizing is needed to improve the surface strength of the paper.

There are different inks or coloured liquids available for sizing tests. In general, it is important to get sufficient colour discrimination between the penetrating liquid and the paper:

- Blue ink in conformance with DIN 53126
- Black ink in conformance with DIN 53126
- All inks as specified in TAPPI T530 can be used. [23]

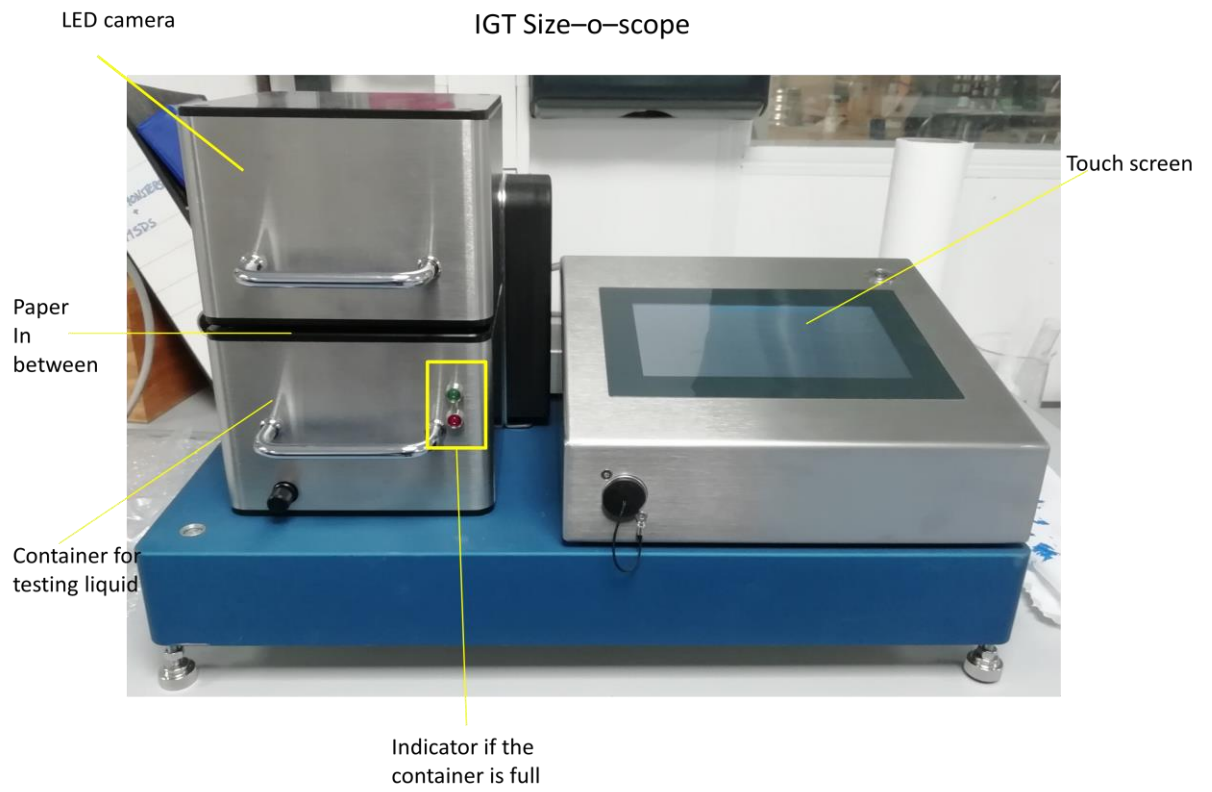

Figure 26 - Size-o-scope

3.4. Printability testing methods

3.4.1. Print penetration (oil absorption)

At the moment of printing a quantity of ink or varnish is absorbed by the surface of the paper. This amount is determined by the absorption of liquid in the surface recesses (roughness) and the absorption into the paper pores at the surface. [24]

In print penetration test method, a large stain indicates a low roughness/absorption of the paper. This is then called print penetration. Between the printing disc and a paper stripe on the sector of an IGT-printability tester a drop of oil with a volume of 5.8 ± 0.3 mg was spread to a stain. The length of the stain was measured. The stain length was increasing when the roughness and/or absorption of the paper was decreasing. It is recommended to execute the test in the standard atmosphere; to most standards it is 23.0 ± 1.0 °C (73.4 ± 1.8 °F) and $50 \pm 2\%$ rh.

Paper substrates, the test liquid and the equipment were conditioned during 6 or more hours in the standard atmosphere before starting the test. Paper was cut in stripes in size of 55 x 340 mm. Each of the 5 stripes per sample was marked top and/or bottom side, machine and/or cross direction and a code for the type of the material. Before printing, a paper stripe was mounted on the sector of the device. Printing force of the upper printing disc was set to 1000 N and printing speed to 1.2 m/s in the increasing speed mode. The syringe was filled with the coloured testing liquid and mounted to the holder. Drop catcher was then positioned under the needle to collect drops. A drop was falling out of the syringe in regular intervals.

The printing disc was placed on the upper printing disc shaft next to the attached test stripe on the sector. The sector was positioned in the starting position and printing disc was moved in the printing position against the test stripe. Drop catcher was released until one single drop has fallen on the printing disc and placed back to the catching position. Side buttons were pressed to make a print on the substrate and the drop was spread into a stain. The test stripe was then removed from the sector and the stain length

was measured immediately after the test. If the stain length was not measured right after the test, the stain length has to be marked by marking dots. The printing disc was taken off from the shaft and cleaned with a cleaning agent. The test was repeated 10 times for each group of samples. [24]

The stain length was measured by a ruler in mm. Thus, the stain length or varnishability was determined. The print penetration was determined with the formula from the W24/W60 leaflet:

$$\text{Printing penetration} = 1000 / \text{stain length in mm} \quad (1)$$



Figure 26 - IGT AIC2-5 in position for print penetration test

Materials used in this test:

- IGT AIC2-5
- Holder for the syringe
- Syringe Fortuna
- Printing disc, aluminium, 50 mm

- Testing liquid for print penetration, red
- Packing, rubber, 55 mm
- Stripes of paper to be tested

3.4.2. *Set off (0.7 m/s)*

Absorption is the speed of ink penetrating into paper after printing. For the offset printing process this property is very important. If the ink is absorbed too slowly or too fast, it may be the cause of many problems. The absorption that is too slow may result in smearing because the ink does not dry fast enough. An absorption that is too fast may result in a reduction of the dry ink properties, because too much binding agent has penetrated into the paper and mainly the pigments remain at the surface. [25]

A stripe of the paper substrate that was tested was printed with an IGT AIC2-5 printability tester under standard conditions and by using a set off ink. After set intervals the stripe was brought into contact with a blank stripe of a standard set off paper. Part of the ink, which was still present at the surface of the printed strip, was smeared on the set off stripe. The more ink is being absorbed into the printed stripe; the less ink will smear on the set off stripe. The density of the smeared ink is then a value for the absorption. Since smearing mainly concerns the ink, which is at the top of the surface of the paper, the test stripe was printed with a hard (aluminium) printing form.

Paper substrates, the test liquid and the equipment were conditioned during 6 or more hours in the standard atmosphere before starting the test. Paper was cut in stripes in size of 55 x 340 mm. Each of the 5 strips per sample was marked top and/or bottom side, machine and/or cross direction and a code for the type of the material. Reference paper for set off test, IGT C2846 paper, was cut to a length of 200 mm. Printing force of the upper printing disc was set to 1000 N and printing speed to 0.7 m/s in the constant speed mode. It is recommended to execute the test in the standard atmosphere; to most standards it is 23.0 ± 1.0 °C (73.4 ± 1.8 °F) and $50 \pm 2\%$ rh. The ink pipette was filled with the set off ink. [25]

High speed inking unit, which is connected to the water bath which controls the temperature, was used to equally distribute and apply the set off ink on the printing disc with the following settings:

- Water bath: 23.0 °C (73.4 °F)
- Top roller: 4-segmented, rubber for conventional inks
- Mode: 2
- Starting time: 10 s
- Distribution time: 20 s
- Distribution speed: 0.5 m/s
- Inking time printing discs: 15 s

The test stripe was attached to the sector by using the front clamp on one side and sticky tape on the other side. A set off test stripe (reference paper) was mounted to a clean printing disc with a sticky tape and mounted to the bottom disc shaft of the AIC2-5 printability tester. By using the ink pipette, an amount of 0.17 cm³ of ink was applied to the high-speed inking unit. A new printing disc was placed on the printing disc shaft of the inking unit and inked during the pre-set time. After the ink was equally distributed on this disc, it was placed on the top printing disc shaft of the AIC2-5 printability tester. The interval time was set to 3 s. The print and set off were made immediately and another set off after 3 seconds. The printed paper substrate stripe and the set off stripe were taken off and stored for 4 or more hours in a conditioned room. After the test, the printing disc was cleaned. The test was repeated 3 to 4 times for each group of samples.

After the prints were dry, a contrast density on the set off stripes was measured. Density of smeared, translated ink was used to express the absorption rate. Density was measured at 5 spots across the length of a print with a Techkon Spectrodens to calculate the average value. Part of the ink that was still present at the surface of the printed stripe was smeared on the set off stripe. The more ink absorbed into the printed stripe equals the less ink smeared on set off stripe. [25]

Materials used:

- IGT AIC2-5
- High speed inking unit
- Top roller with 4 segments for conventional inks
- IGT ink pipette, resolution 0,01 ml
- Printing disc, aluminium, 55 mm
- Packing, paper, 55 mm
- IGT set off ink
- Stripes of reference paper, IGT C2846, 55 mm
- Techkon spectrodens, densitometer



Figure 27 - IGT AIC2-5 in position for set off test

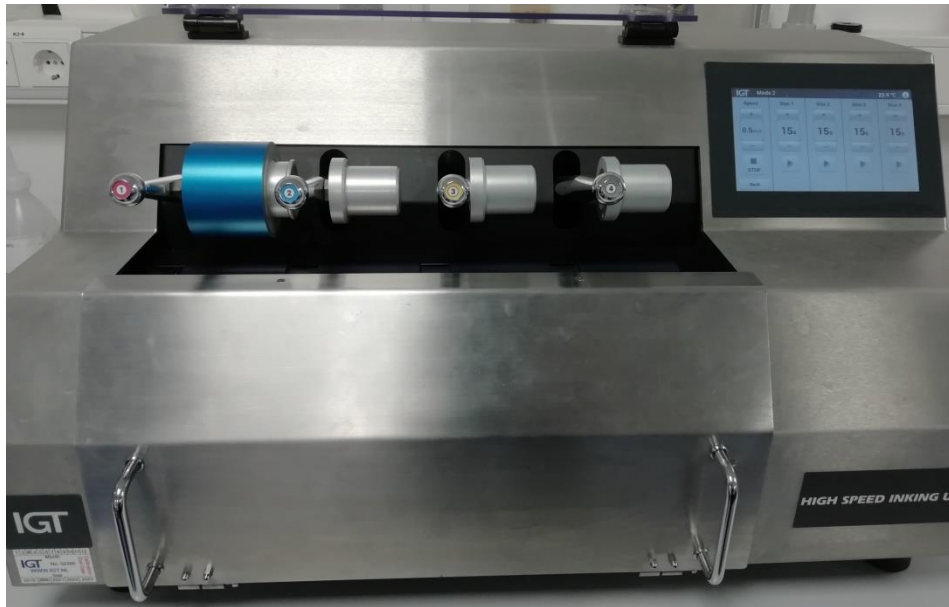

Figure 28 - IGT High speed inking unit

3.4.3. Colour/density/transfer (aluminium printing disc)

Most of the printability tests are performed on the basis of a known ink film thickness on the printing form (printing disc); the real amount of ink on the paper is not known. In many cases it is better to know the exact amount of ink on the paper because small differences can highly influence the properties. For that reason, it is advisable to make the print in combination with the ink transfer in g/m^2 . Direct measurement on the printed paper is not possible. For that reason, the ink transfer is calculated in g/m^2 from the difference in weight of the printing form before and after the printing and the sizes of the print. [27]

The paper stripe was printed with an ink on the Amsterdam-6 printability tester. Before and after the printing the printing form (disc) was weighed on a precision scale with an accuracy of 0.1 mg or better. From these weights and the sizes of the print the ink transfer was calculated as g/m^2 . It is recommended to execute the test in the standard atmosphere; to most standards it is $23.0 \pm 1.0 \text{ }^\circ\text{C}$ ($73.4 \pm 1.8 \text{ }^\circ\text{F}$) and $50 \pm 2\%$ rh.

Paper substrates, the test liquid and the equipment were conditioned during 6 or more hours in the standard atmosphere before starting the test. Paper was cut in stripes in size of 55 x 340 mm. Each of the 3 stripes per sample was marked top and/or bottom side, machine and/or cross direction and a code for the type of the material.

High speed inking unit was adjusted with the following settings:

- Water bath: 23.0° C (73.4° F)
- Top roller: 4-segmented, rubber for conventional inks
- Mode: 2
- Starting time: 10 s
- Distribution time: 20 s
- Distribution speed: 0,5 m/s
- Inking time printing disc: 15 s

The press of a print button on a built-in touch screen computer moved the first shaft into the starting position. A test stripe was attached onto the sector of the Amsterdam-6 printability tester. On the high-speed inking unit, a quantity of 0.10 cm³ was applied and evenly distributed during the pre-set time by using the ink pipette. The inked printing disc was then placed on the precision scale and weighed (*weight = G1 [g]*). The printing disc was then placed on the first shaft of the printability tester and a print was made onto the mounted substrate on the sector. Immediately after the print, the printing disc was weighed again (*weight = G2 [g]*). The printed stripe was removed from the sector and the printing disc was cleaned. After the print was dry, the length (*L*) and the width (*W*) of the print were measured in cm. [27]

The assessment was done by calculating the ink transfer with the formula:

$$\text{Ink transfer} = \{10,000 / (L * W)\} * (G1 - G2) \quad (2)$$

Where:

L = length of the print in cm

W = width of the print in cm

G1 = weight of the printing disc with ink before printing in g

G2 = weight of the printing disc with ink after printing in g

After the prints are dry, the contrast density was measured. It provides the relationship between weight and density of colour. The test was repeated 3 times for each group of samples.

Materials used:

- IGT Amsterdam
- High speed inking unit
- Top roller with 4 segments for conventional inks
- IGT ink pipette, resolution 0.01 ml
- Printing disc, aluminium, 55 mm
- Packing, paper, 55 mm
- IGT set off ink
- Stripes of paper to be tested
- Techkon spectrodens, densitometer
- Electronical analytical balance

3.4.4. Wet pick / wet repellence (rubber 85 Shore A)

In offset printing, the fact that water, as well as ink, is transferred to paper may lead to many complications. Where the paper has been wetted several times, water may affect ink transfer, because it changes the surface structure of the paper. Water can weaken the paper surface to such an extent that paper particles are pulled off from the surface by the tack of the ink. This phenomenon is known as wet pick. Another effect of water is that the paper does not accept ink due the water not completely penetrating into the paper. This is called wet repellence. During offset printing a moisture film of about 0.2 to 0.3 μm (0.2 to 0.3 g/m^2) per colour is applied to the paper. This test simulates the multicoloured printing process. [26]

The damping unit consists of a screened damping disc with doctor blade and a printing disc. An excess of damping fluid was applied to the disc, which was then metered by a doctor blade. The amount of fluid remaining on the damping disc was

transferred to the paper, which was printed on with a standard ink, if required after the set time interval. After this, the printed sample was checked on wet pick or wet repellence. There are also damping discs available for the application of moisture films of 0.25, 0.5 and 1.0 μm . It is recommended to execute the test in the standard atmosphere; to most standards it is 23.0 ± 1.0 °C (73.4 ± 1.8 °F) and $50 \pm 2\%$ rh.

Paper substrates, the test liquid and the equipment were conditioned during 6 or more hours in the standard atmosphere before starting the test. Paper was cut in stripes in size of 55 x 340 mm. Each of the 5 stripes per sample was marked top and/or bottom side, machine and/or cross direction and a code for the type of the material. Printing force of both printing discs was set to 625 N and printing speed was set to 1 m/s in the constant speed mode. Doctor blade was mounted on the doctor blade holder and the damping disc was cleaned with a towel soaked in ethanol. The damping disc was then placed on the first shaft of the tester. Piece of a cotton cloth was cut to about 5 x 50 mm² and placed on to the damping disc just behind the doctor blade. The ink pipette was filled with a desired pick test ink. [26]

High speed inking unit is adjusted with the following settings:

- Water bath: 23.0° C (73.4° F)
- Top roller: 4-segmented, rubber for conventional inks
- Mode: 2
- Starting time: 10 s
- Distribution time: 20 s
- Distribution speed: 0,5 m/s
- Inking time printing discs: 15 s

Printing speed and interval time, if needed, can be adjusted. First a test stripe is manually mounted onto the sector and then a press of a print button on the touch screen computer on the device rotates the shafts into a starting position. By using the ink pipette, an amount of 0.14 cm³ of ink was applied to the high-speed inking unit. A new printing disc was placed onto the printing disc shaft of the inking unit and inked during the pre-set time. After the ink was equally distributed on this disc, it was placed to the

second printing disc shaft of the Amsterdam-6 printability tester. By pressing the side buttons at the same time, the sector was moved into the starting position and the blade positioned itself on to the dampening disc. A few drops of water were then applied onto the cotton stripe. No extra interval time was used. Another press on both side buttons at the same time initiated the paper dampening and directly made the print on the dry and dampened paper at the speed of 0.7 m/s. The test stripe was taken off the sector and replaced with a stripe of IGT C2846 reference paper. The second print was made and then taken off the sector. The printing disc and the inking unit roller were cleaned. The test was repeated 4 times for each group of samples for dampening unit of 0.5 ml/m² and 3 times for each group of samples for dampening unit of 1.35 ml/m². [26]

Assessment can be done in two ways; visually and densitometrically.

1. VISUALLY (d = density)

- No wet pick / no wet repellence: $dA = dB$ and $dC = dD$. There are no paper particles on the printing disc after the first print.
- Wet repellence: $dA > dB$ and $dC < dD$. There are no paper particles on the printing disc after the first print.
- Wet pick: $dA > dB$ and $dC > dD$. There are paper particles on the printing disc after the first printing.

2. DENSITOMETRICALLY (d = density)

After the ink was dry, the contrast density of the areas A, B, C and D was measured. The drying time of the IGT ink is about 30 minutes. The wet pick and the wet repellence are then calculated with the following formulas:

$$(a) \text{ Wet pick + wet repellence} = [(dA - dB) / dA] * 100\%$$

$$(b) \text{ Wet pick} = [(dC - dD) / dC] * 100\%$$

$$(c) \text{ Wet repellence} = (a) - (b)$$

The results of this calculation mean the following:

- No wet pick / no wet repellence: $(a) = 0$
- Wet pick: $(b) > 0$. A higher value = more wet pick

- Wet repellence: $(c) > 0$. A higher value = more wet repellence

Materials used:

- IGT Amsterdam
- High speed inking unit
- Top roller with 4 segments for conventional inks
- IGT ink pipette, resolution 0.01 ml
- Doctor blade for dampening units
- Dampening disc for 0.5 μm of water
- Printing disc with black rubber, 85 Shore A, pin, 50 mm
- Packing, paper, 55 mm
- IGT pick test ink
- Stripes of reference paper, IGT C2846, 55 mm
- Stripes of paper to be tested
- Dampening fluid (water)
- Cotton strip 5 x 50 mm^2
- Techkon spectrodens, densitometer



Figure 29 - IGT Amsterdam-6

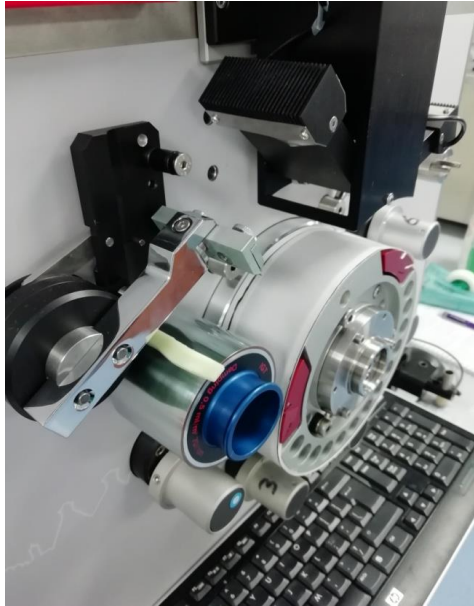

a)



b)

Figure 30 - a) Dampening unit on IGT Amsterdam-6; b) Densitometer

4. RESULTS AND DISCUSSION

The abbreviations indicate the group G or F as a method used to apply the coating as stated in the introduction of the experimental part and also the percentage and type of the coating used. Table view of the sample groups is attached in appendix 1.

4.1. Testing methods for surface characteristics

4.1.1. Air permeability Bendsten

Table 1. Results of the Air permeability test, average and standard deviation

	uncoated	G3%MCC	G4%MCC	F3%MCC	F4%MCC	G4%NCC	F4%NCC
Average air permeability (ml/min)	348,44	97,76	63,15	52,97	48,25	94,71	74,95
Standard deviation	20,88	12,11	19,62	6,99	25,84	40,10	28,27

For uncoated paper, measurements were first done at 300 ml/min, but the result was not precise enough, so it was decided to measure these samples at 3000 ml/min. Since the coated samples have shown the opposite, they were measured at 300 ml/min.

Since it is being researched if this type of coating can be used for food packaging it was necessary to have a coating with a low air permeability property so the food could stay fresh. Table 1 shows that samples F3%MC and F4%MC, which are both coated with MCC, have more closed surface than the other tested samples. This can be explained by the MCC particles being bigger in size than the NCC particles. Looking only at the NCC coating it can be concluded that the sample F4%NCC has a more closed surface than the G4%NCC sample. The reason for that could be the application process. It is clear from the standard deviation that the most uniformly applied coating is noted on samples G3%MC and F3%MC. The standard deviation may therefore indicate the coating unevenness of these samples and also the cloudiness of the base paper. Appendix 2 outlines the values of the table in the graph.

4.1.2. Size-o-scope

Luminance is the amount of light given out in a particular direction from a particular area. [28]

For each group of papers luminance was measured at 300 s and graph 1 shows the average for each one. The measurement was adjusted to a shorter time. It was set to 300 s due to luminance taking too much time to drop to 80%. Unlike uncoated paper, other samples luminance ranges from 92 % to 94 %. When comparing the coated samples with an uncoated one, it can be concluded that MCC and NCC coatings have a barrier to water. The testing was done with blue ink in conformance with DIN 53126.

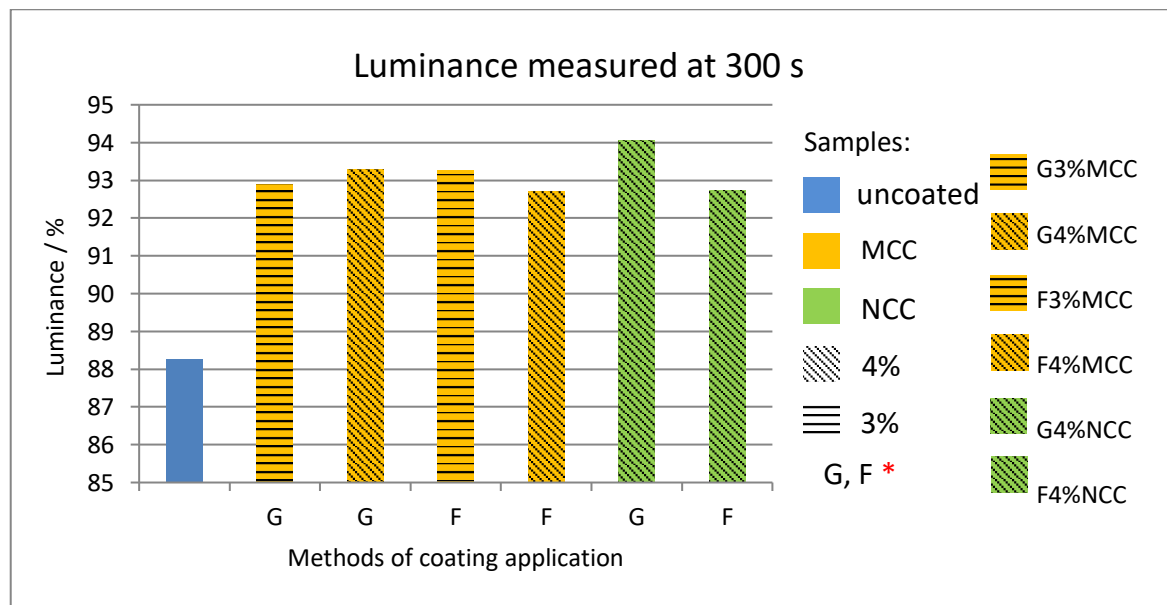

*G-gravure printing method with cleaning before each of 5 layers; F - gravure printing method without cleaning before each of 5 layers

Graph 1 - Luminance at 100 % average for each group of papers

All samples coated with MCC coating practically do not differ at all and they behave more or less equally. When comparing the two NCC samples a difference between the samples can be seen. A difference between G4%NCC and F4%NCC is also present. Those differences could have been caused by the coating application process.

Graph 2 shows how much time was needed for luminance to drop from 100% to 99%. Sample F4%NCC took the longest time to be measured, which indicates a better

barrier property. It can be stated that for short periods of time, MCC and NCC coatings have some barrier properties to water. These coating layers are very thin so the barrier properties may not be of much importance, but this test proves that they do exist.

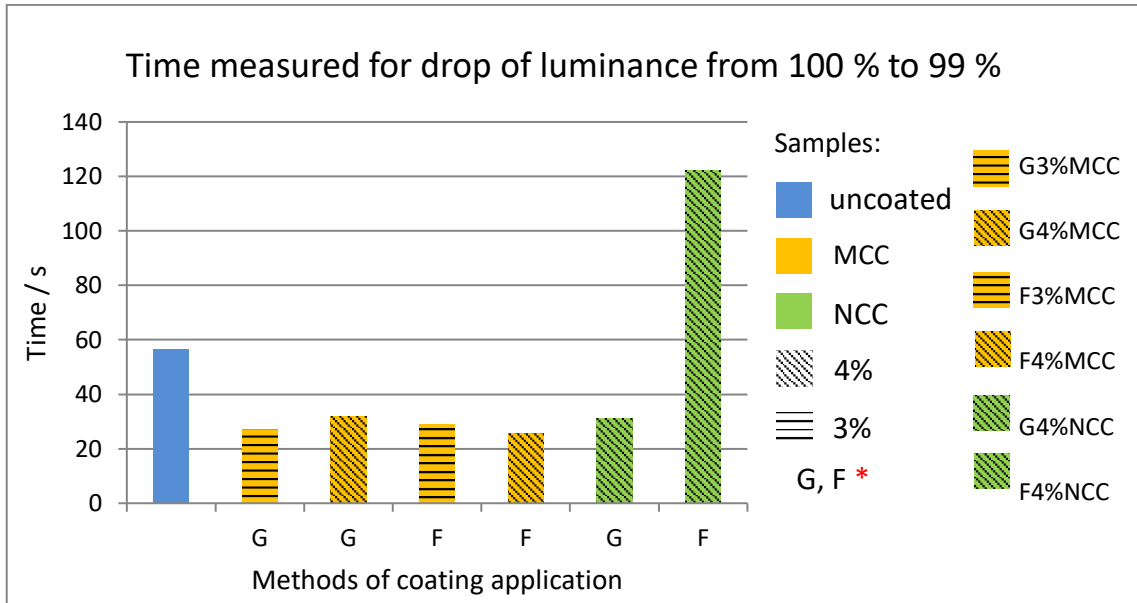

*G-gravure printing method with cleaning before each of 5 layers; F - gravure printing method without cleaning before each of 5 layers

Graph 2 - Time needed for luminance to drop from 100 % to 99 %

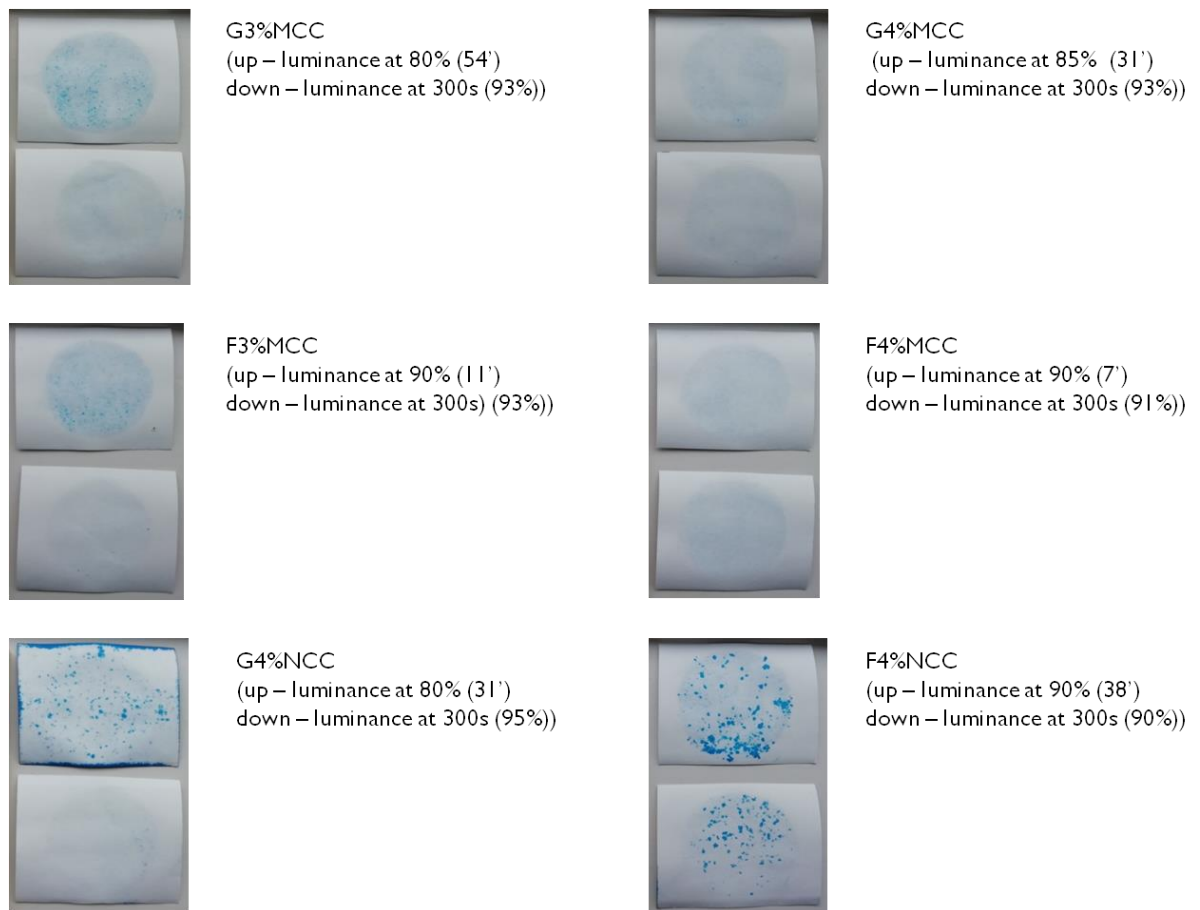

Figure 31 - Back of the paper samples where the luminance was measured by a camera

Figure 31 shows samples for each group of papers from the backside, where difference in luminance is measured. First sample in each photo was tested until the luminance dropped to 80 %, or if it took too long, to 90 %. The second sample in each photo is taken after 300 s and measured luminance right after that set time is shown in table 4. It can be concluded that MCC and NCC can be used as a coating on paper surface because they show barrier properties to water. Data table of size-o-scope results is shown in Appendix 3.

4.2. Printability testing methods

4.2.1. Print penetration (oil absorption)

At the moment of printing a quantity of ink or varnish is absorbed by the surface of the paper substrate. This amount is determined by the absorption of liquid in the surface recesses (roughness) and the absorption into the paper pores at the surface. The sum of these two phenomena is determined as the oil absorption or varnishability. The reciprocal value of this is called print penetration.

Table 2. Results from the print penetration test, average stain length and print penetration

	uncoated	G3%MCC	G4%MCC	F3%MCC	F4%MCC	G4%NCC	F4%NCC
Average length of stain (mm)	38,19	47,35	53,8	52,05	54,1	53,63	60,25
Print penetration (mm⁻¹)	26,19	21,12	18,59	19,21	18,48	18,65	16,59

It can be concluded from table 2 that the NCC samples have the largest stain length. This indicates low absorption of the paper. It means that the liquid does not penetrate into the paper, but it spreads along the surface of the coating. Print penetration is the reciprocal value of the stain length multiplied by 1000 and it shows that NCC offers a better barrier towards penetration liquid. The higher the value of print penetration, the better the oil absorption. This could cause some problems in printing; therefore, a further research needs to be conducted. It can also be concluded that MCC and NCC coatings can make a possible grease barrier, which should be further explored with different combinations of MCC and NCC coatings and different coating thicknesses. Figure 32 shows visual examples for each group of papers and Figure 33 shows uncoated paper samples.

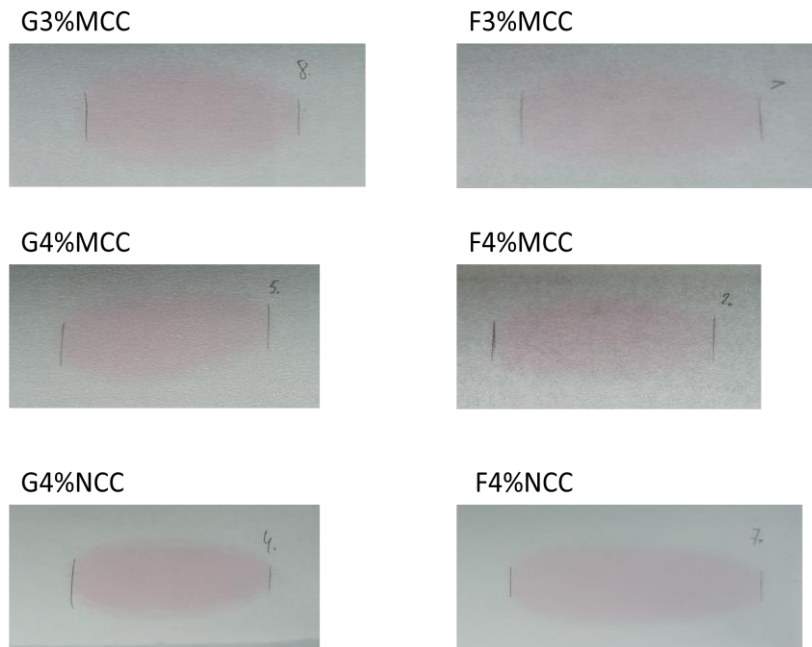

Figure 32 - Stains made on the coated side of the paper to test print penetration

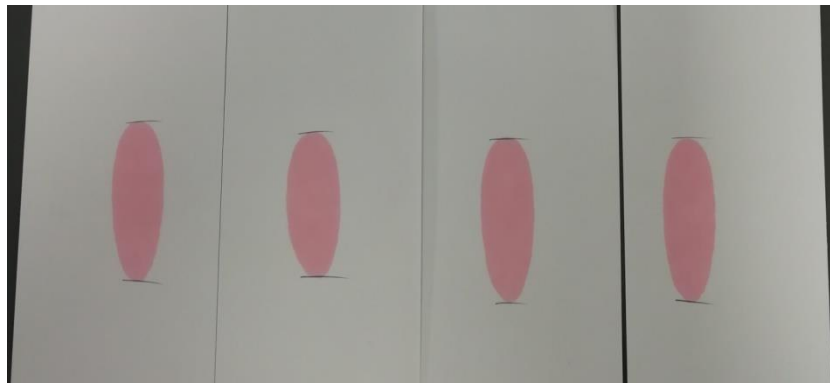

Figure 33 - Print penetration test on uncoated base paper

Later on, with further drying, it was visible that uncoated paper had bigger stain length. This happened due to the penetration of the testing oil through the structure of the uncoated paper, while the coated samples did not show such noticeable difference. This proves the coating applied creates a barrier.

4.2.2. Set off (0.7 m/s)

Part of the ink that is still present at the surface of the printed stripe will smear on the set off stripe. The more ink is being absorbed into the printed stripe the less ink will smear on the set off stripe. High density shows that more ink was absorbed into the paper.

Figure 34 explains the printed and set off sections of the test. Part A is printed and immediately set off on the reference paper before the ink had time to penetrate into the paper and/or dry. Part B is also a set off but after set time of 3 s. During that time the ink had time to penetrate and/or dry on the test stripe. Excess of ink was then set off on the reference paper. Part C was only printed, without setting off. The result was visible in the colour difference.

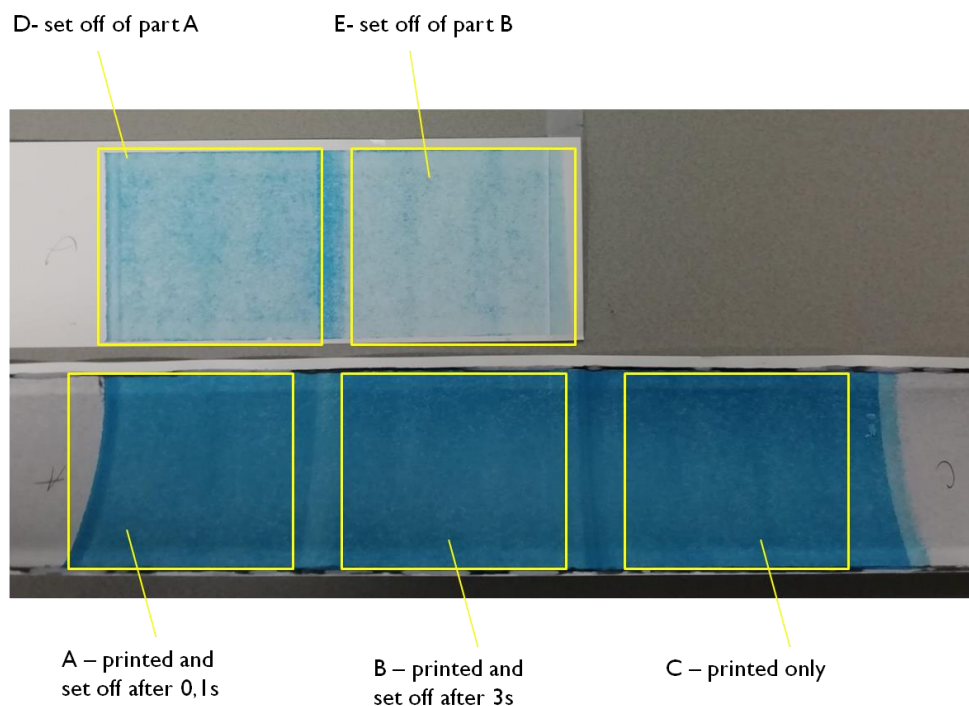

Figure 34 - Explanation of sections on printed stripes

In table 3 it can be seen that part C of the paper has higher value in colour density than the part which was printed and immediately set off after 0,1 s (part A). Sample G4%NCC has the highest density, which means that this coating on paper sample is

more printable than the other samples. The coating of G4%NCC does not repel ink as well as F3%MCC, which has the lowest contrast density out of all samples. It can be concluded that this type of coated papers can be printed on, but the drying time should be prolonged to prevent “ghosting” of the print on the next sheet.

Table 3. Results of the Set off test, contrast density for each section of the print

Contrast density (D)	uncoated	G3%MCC	G4%MCC	F3%MCC	F4%MCC	G4%NCC	F4%NCC
printed and set off after 0,1s	0,616	0,598	0,543	0,563	0,621	0,721	0,698
printed and set off after 3s	0,684	0,608	0,655	0,618	0,704	0,786	0,757
printed only	0,754	0,737	0,763	0,661	0,806	0,965	0,918
set off of part A	0,256	0,279	0,278	0,305	0,304	0,392	0,399
set off of part B	0,164	0,194	0,187	0,187	0,187	0,265	0,260

Figure 35 shows results of different groups of paper. When the stripe parts A and B are lighter in colour than part C, it shows that the ink does not stick to the coating applied on the paper and that it will be transferred to the set off stripe as parts D and E.

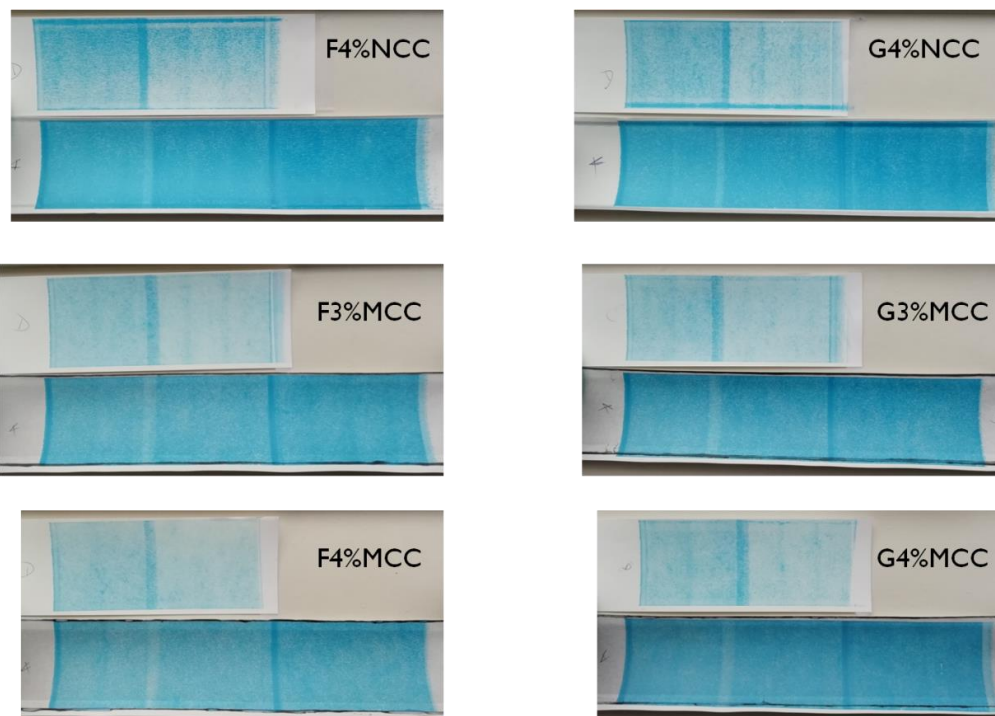
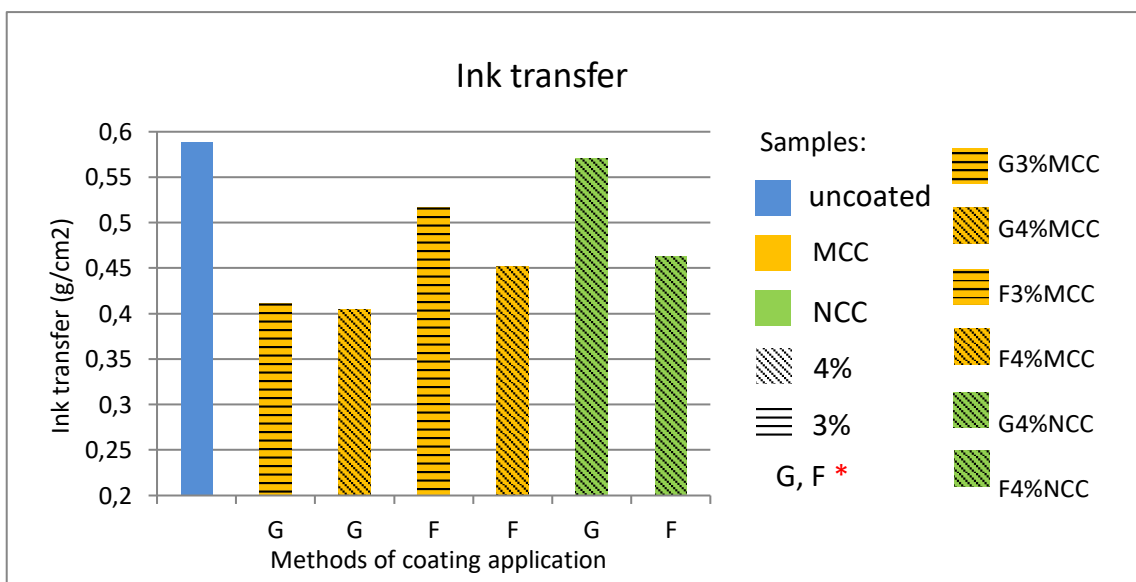

Figure 35 - Visual for each group of papers, upper: set off stripe, lower: test stripe sample

4.2.3. Colour/density/transfer (aluminium printing disc)

This test was performed to confirm that the results from the set off test are valid. It shows that the amount of ink applied can affect the density of colour, which can be seen in graph 3. In conclusion, they did confirm the set off test results. There is a possible sampling mistake made by the application of the ink amount. Ink transfer test showed that the amount of ink applied is connected with the value of the colour density. Figure 36 shows samples for each group of papers. Data table of ink transfer results is shown in Appendix 4.



*G-gravure printing method with cleaning before each of 5 layers; F - gravure printing method without cleaning before each of 5 layers

Graph 3 - Ink transfer calculated for each group of samples

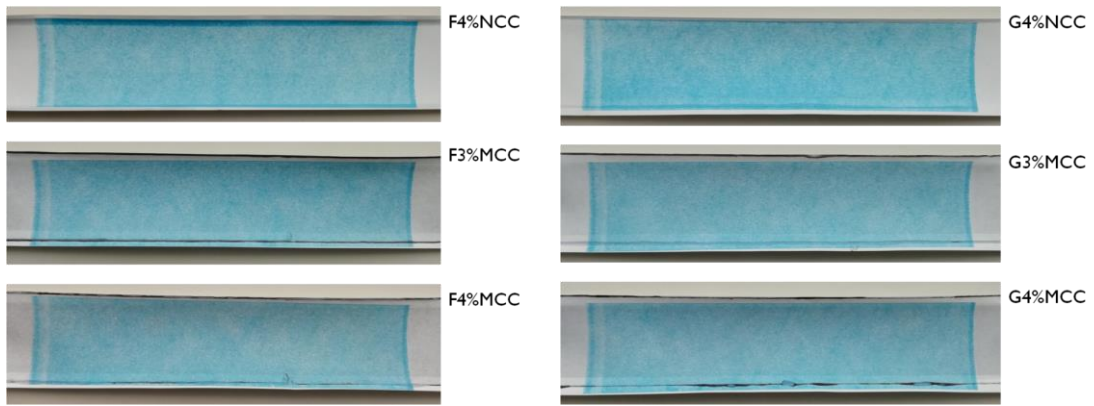

Figure 36 - Visual for each group of papers

4.2.4. Wet pick / wet repellence (rubber 85 Shore A)

Wet Pick / wet repellence test was performed in order to find out if water can damage the coating and the paper underneath so that ink can penetrate into the paper or if the water is repelled. This may cause problems in printing, such as picking of paper fibres.

Figure 37 shows printed sections. Part A was printed on dry paper. Part B was damped first and then printed. Leftover ink from the printing disc was then printed onto the reference paper. These were the parts C and D.

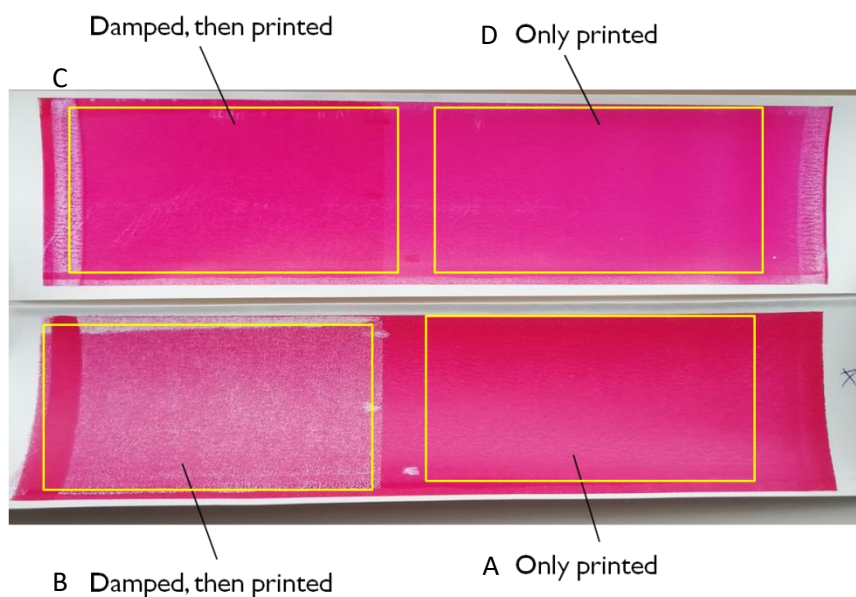
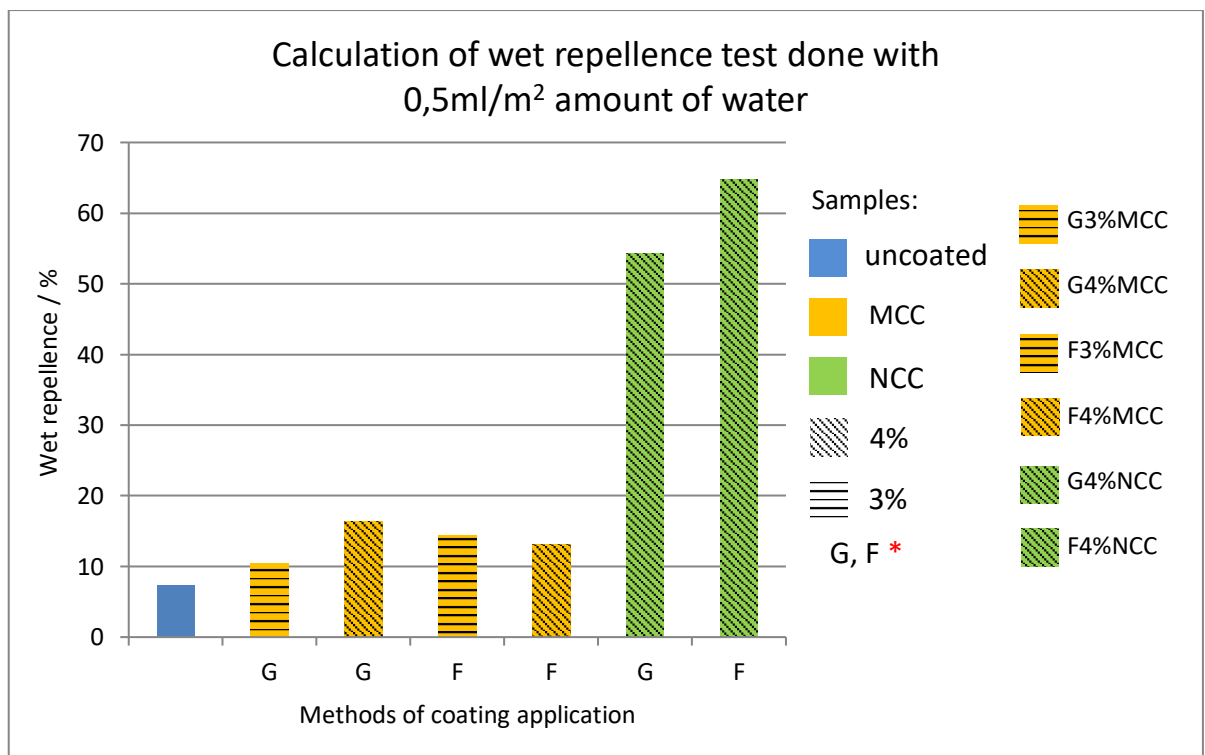

Figure 37 - Explanation of sections on printed stripes

Graph 4 shows that NCC paper has the best wet repellence, which means it repels the water really well. If the coating is going to be used in food packaging, this could prove that it can stop small amount of water from penetrating, but only for a short period of time. When a small amount of water was used for dampening, it turned out that NCC coated samples had better barrier than MCC coated samples. This could be due to a smaller particle size of NCC, i.e. larger surface energy and better cohesion (connection between similar NCC particles) than adhesion (connection between NCC surface and cellulose surface). Water can disrupt MCC coating, which has a bit weaker cohesion to paper, so the ink can penetrate into the paper. Applying a thicker coating layer or a different coating application process can also be considered. It can be concluded that NCC coated papers have better water repellence than MCC coated papers. Data table of wet repellence results for 0.5 ml/m² water amount used is shown in Appendix 5. Figure 38 represents a visual for each group of papers.



*G-gravure printing method with cleaning before each of 5 layers; F - gravure printing method without cleaning before each of 5 layers

Graph 4 – Wet repellence for each group of papers



Figure 38 - Visual for each group of papers

Wet repellence tests made with double the amount of water showed that MCC coated papers have similar barrier properties to NCC coated papers, as shown in graph 5. The amount was doubled due to a sampling mistake where adding too much water in the first test showed to have a big difference in performance of the coating. That is why the test was repeated with a higher water volume to test that theory. It can be concluded that NCC coated papers still have a better water repellence than MCC coated papers, although in this test MCC coated papers gave better results than the test conducted with a small amount of water. Data table of wet repellence results for 1.35 ml/m² water amount used is shown in Appendix 5.

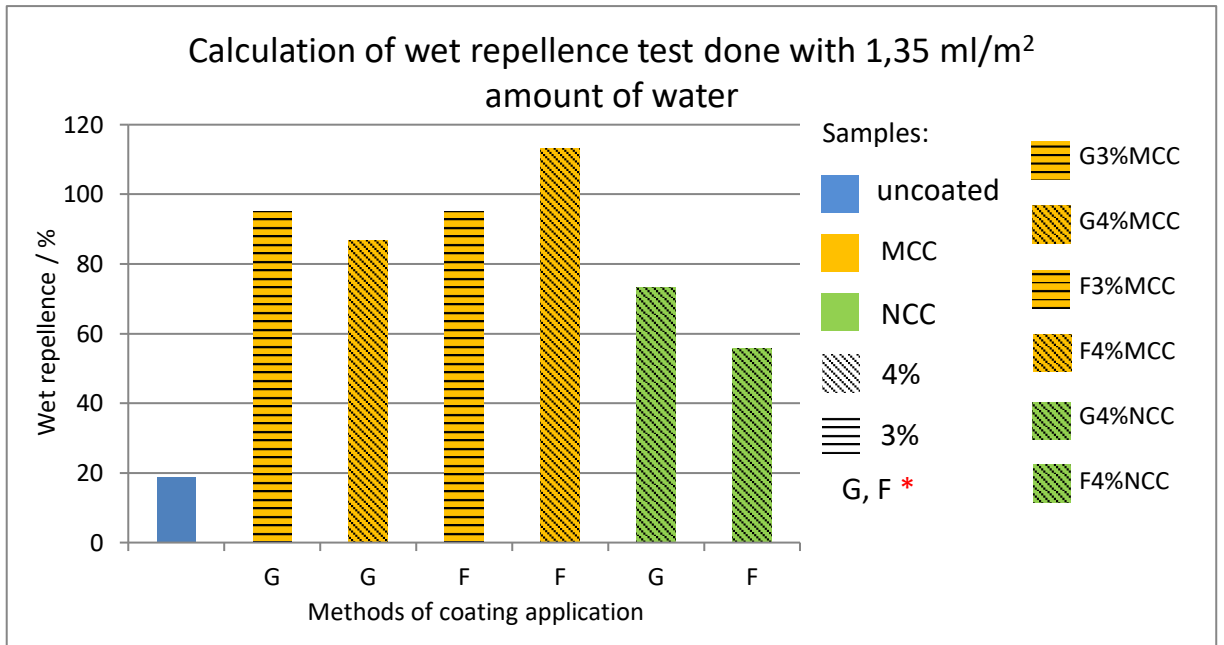

*G-gravure printing method with cleaning before each of 5 layers; F - gravure printing method without cleaning before each of 5 layers

Graph 5 - Wet repellence for each group of papers

Figure 39 shows samples for each group of papers. As explained with the graphs above it can be concluded that both groups of paper have a similar barrier to water.

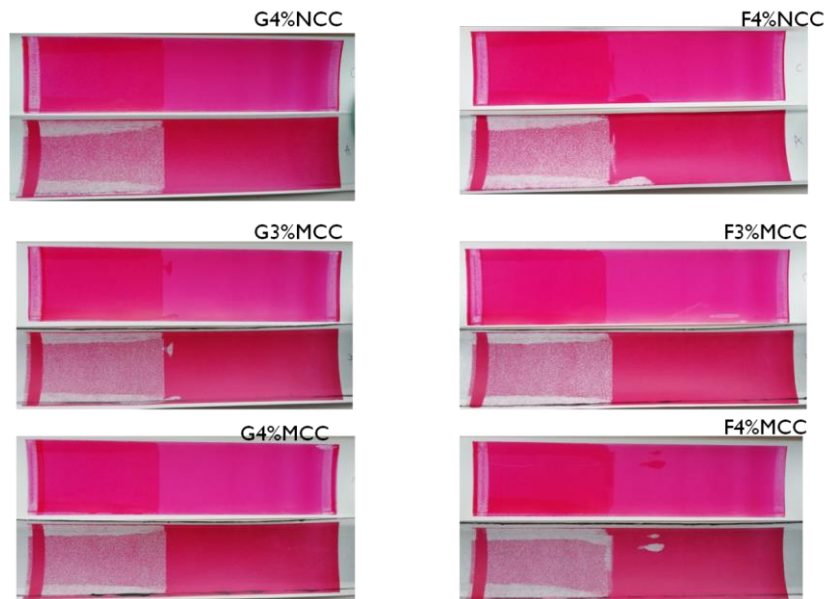
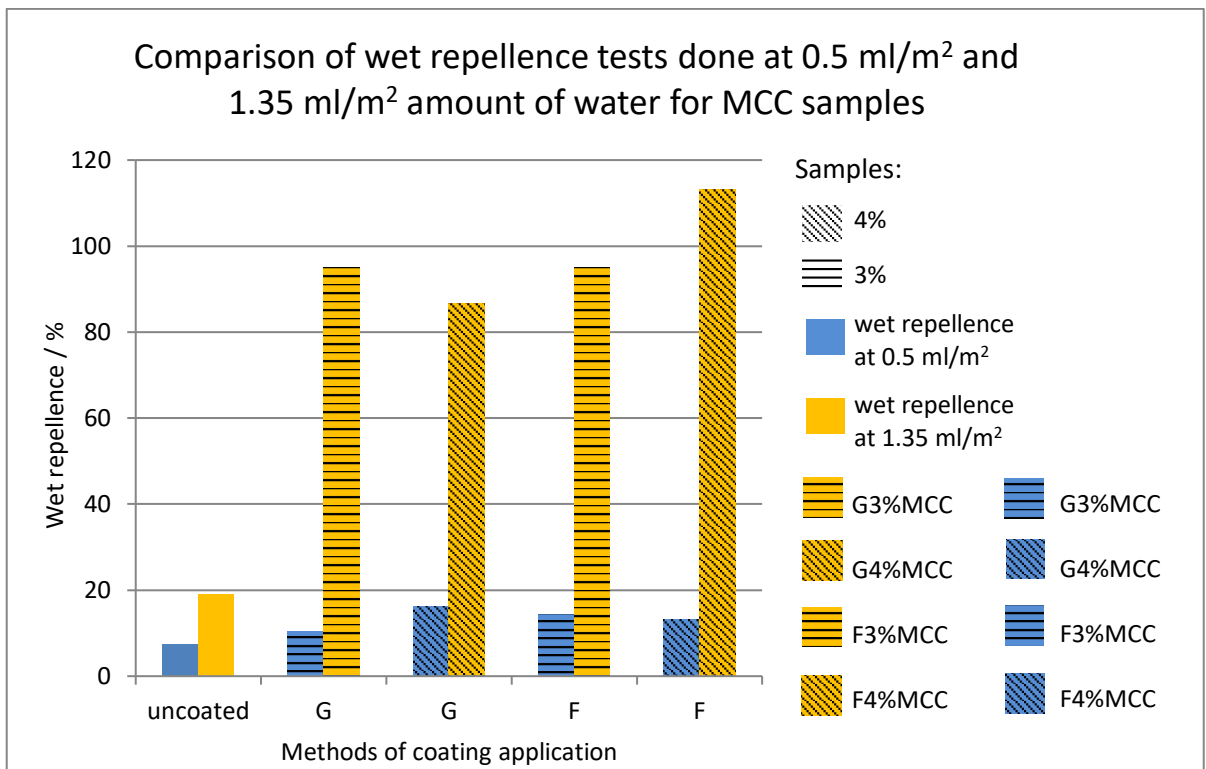

Figure 39 - visual for each group of papers

Graphs 6 and 7 show comparison between the same tests performed with a different amount of water for both MCC and NCC samples. The NCC coated paper has good wet repellence at 0.5 ml/m² and 1.35 ml/m², while MCC coated paper has a good and even better wet repellence at 1.35 ml/m² than NCC, but has a really bad wet repellence at 0.5 ml/m². This test shows that during printing, water is not absorbed immediately but stays on the surface and can repel the ink without causing the wet pick. Data table of wet repellence results for both water amounts used is shown in Appendix 5.



*G-gravure printing method with cleaning before each of 5 layers; F - gravure printing method without cleaning before each of 5 layers

Graph 6 - Comparison of wet repellence tests done at 0.5 ml/m² and 1.35 ml/m² amount of water for MCC samples

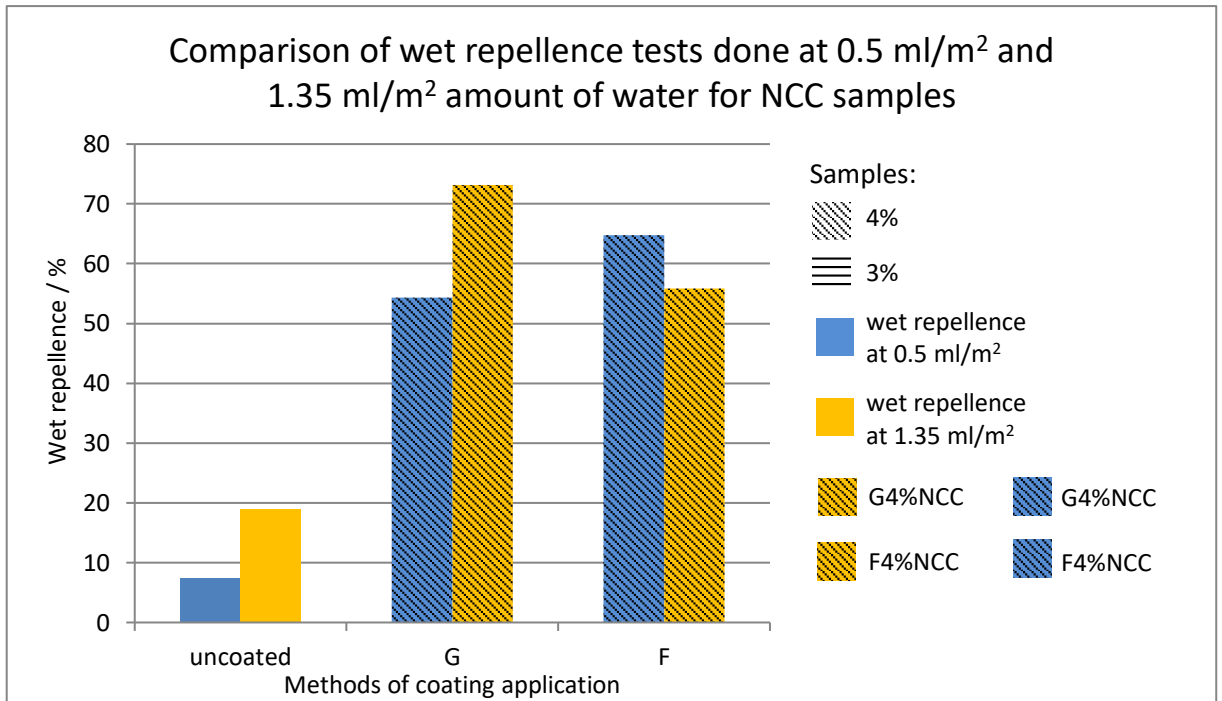

*G-gravure printing method with cleaning before each of 5 layers; F - gravure printing method without cleaning before each of 5 layers

Graph 7 - Comparison of wet repellence tests done at 1.35 ml/m² and 1.35 ml/m² amount of water for NCC samples

5. CONCLUSION

A novel method was used to apply a coating on the paper surface. The printability tester IGT F1 was used to apply the coating in a more precise way by using two different methods. Each application method showed to have advantages, depending on the test performed and final coating purpose. Compared with the uncoated paper, coated samples had noticeable barrier properties.

From the air permeability test, it can be concluded that the best barrier is shown by Group F samples made with 3% and 4% MCC. Other sample groups have better barrier properties compared to uncoated paper, but slightly weaker properties compared to group F samples made with 3% and 4% MCC. The size-o-scope measurement showed that all tested samples have good barrier properties to water during a short period of time. This indicates that with application of a thicker coating or a combination of MCC and NCC, it might be possible to achieve good water barrier properties.

Print penetration tests showed that NCC coated paper samples had a barrier to oil as well as denser coatings of MCC from both groups, G and F. This means that the oil remains in the coating layer and takes longer to penetrate into the paper surface.

Set Off test proved that it is possible to print on MCC and NCC coated sheets of paper, but the results vary. The ink does not penetrate into the coating, since more ink was transferred to the set off paper stripe, which means that it needs prolonged drying time so that it does not come to “ghosting” of the print. NCC coated papers have a greater ink rejection in comparison with the MCC coated papers.

Ink transfer test method confirmed the set off test. The ink does not penetrate from the coating into the paper and therefore stays on the printing roller, resulting in a slight change in the printing form (roller) weight.

Wet repellence test confirmed the size-o-scope test. Both NCC and MCC coated papers have barrier properties to small amounts of water during a short time.

To sum up, for the food packaging materials the NCC coating showed to be a better choice than the MCC coating. Due to a limited amount of materials and equipment, additional research will be needed from the point of view of the graphic technology and of the food industry so that such coatings could be used and eventually replace some of the plastic food packaging, made of polypropylene.

6. REFERENCES

1. Čorlukić, F. (1987). Tehnologija papira, Školska knjiga, Zagreb
2. Kipphan, H. (2000). Handbook of print media Technologies and production methods, Heidelberg
3. Puceković, N. (2014). Development of bio-based materials in printing, Master thesis, Grafički fakultet, Zagreb
4. Lozo, B. (2014). Papir, Preddiplomski studij Grafičke tehnologije, Nastavni tekstovi, Grafički fakultet, Zagreb
***<http://materijali.grf.unizg.hr/media/Nastavni%20materijali%20kolegij%20Papir.pdf> (19.1.2020.)
5. Holik H. (2006). Handbook of Paper and Board, WILEY-VCH Verlag GmbH & Co. KGaA, Weinheim
6. Liehtinen, E. (2006). Papermaking science and technology, Pigment coating and surface sizing of paper, Paper Engineers' Association/Paperi ja Puu Oy, Finland
7. ***<https://www.smithers.com/industries/packaging/manufacturers-and-users/packaging-materials-testing/paper-testing-other-properties/water-absorbency> (19.1.2020.)
8. ***<http://printwiki.org/Opacity> (19.1.2020.)
9. Brinchi, L., Cotana, F., Fortunati, E. & Kenny, J. M. Production of nanocrystalline cellulose from lignocellulosic biomass: Technology and applications. Carbohydr. Polym.94, 154–169 (2013).
10. Ribeiro, R. S. A., Pohlmann, B. C., Calado, V., Bojorge, N. & Pereira, N. Production of nanocellulose by enzymatic hydrolysis: Trends and challenges. Eng. Life Sci.19, 279–291 (2019).
11. Isogai, A., Hänninen, T., Fujisawa, S. & Saito, T. Review: Catalytic oxidation of cellulose with nitroxyl radicals under aqueous conditions. Prog. Polym. Sci.86, 122–148 (2018).
12. Lavoine, N., Desloges, I., Khelifi, B. & Bras, J. Impact of different coating processes of microfibrillated cellulose on the mechanical and barrier properties of paper. J. Mater. Sci.49, 2879–2893 (2014).

13. Habibi, Y., Lucia, L. A. & Rojas, O. J. Cellulose Nanocrystals: Chemistry, Self-Assembly, and Applications. *Chem. Rev.*110, 3479–3500 (2010).
14. Reverdy, C. et al. One-step superhydrophobic coating using hydrophobized cellulose nanofibrils. *ColloidsSurfaces A Physicochem. Eng. Asp.*544, 152–158 (2018).
15. Peresin, M. S. et al. Understanding the mechanisms of oxygen diffusion through surface functionalized nanocellulose films. *Carbohydr. Polym.*174, 309–317 (2017).
16. Larsson, P. & Wagberg, L. Oxygen and water vapour barrier films with low moisture sensitivity fabricated from self-cross-linking fibrillated cellulose. (2014).
17. Shimizu, M., Saito, T. & Isogai, A. Water-resistant and high oxygen-barrier nanocellulose films with interfibrillar cross-linkages formed through multivalent metal ions. *J. Memb. Sci.*500, 1–7 (2016).
18. Aulin, C., Gällstedt, M. & Lindström, T. Oxygen and oil barrier properties of microfibrillated cellulose films and coatings. *Cellulose*17, 559–574 (2010).
19. G. Thoorens, F. Krier, B. Leclercq, B. Carlin, B. Evrard, Microcrystalline cellulose, a direct compression binder in a quality by design environment—A review, *International Journal of Pharmaceutics*, Volume 473, Issues 1–2, 2014, Pages 64-72, ISSN 0378-5173
20. M. Hanna, G. Biby, V. Miladinov, Production of microcrystalline cellulose by reactive extrusion, Patent NO.: US 6,228,213 B1, Date of Patent: May 8, 2001
21. E.L. Braunstein, R.L. Dostie, K.H. Germaano, S.C. Lamb, C.S. Penet, P.B. Richards, Crystalline cellulose production, Patent Number: 5,346,589, Date of Patent: Sep. 13, 1994
22. ***https://www.tse-coating.ch/?page_id=1007&lang=en (23.12.2019.) Figures 11,13,14,15 are taken from this web site
23. ***<https://www.igt.nl/product/sizeoscope/> (20.12.2019.)
24. IGT information leaflet W24/W60
25. IGT Information leaflet W48
26. IGT Information leaflet W32
27. IGT Information leaflet W50/72/80-AMS

28. *******<https://www.oxfordlearnersdictionaries.com/definition/english/luminance?q=luminance> (20.12.2019.)

7. APPENDICES

Appendix 1. Abbreviations of samples used in the research.

Table 4. Explanation of the groups of samples

Abbreviation	Explanation
uncoated	Uncoated base paper
G3%MCC	Group G 3% micro cellulose
G4%MCC	Group G 4% micro cellulose
F3%MCC	Group F 3% micro cellulose
F4%MCC	Group F 4% micro cellulose
G4%NCC	Group G 4% nanocellulose
F4%NCC	Group F 4% nanocellulose

Appendix 2. Outlines the values of the table in a graph.

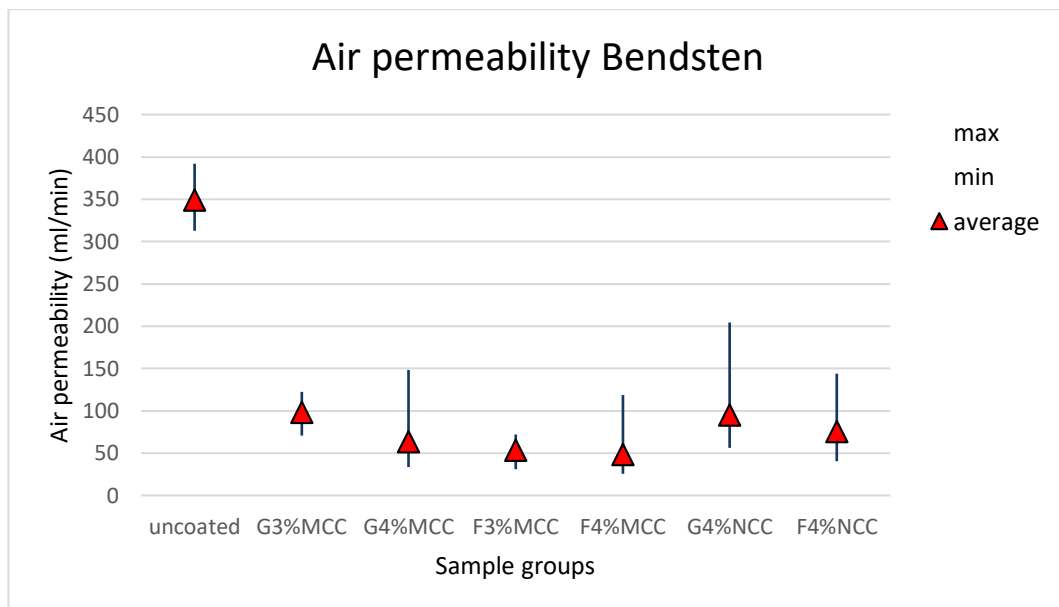

Graph 8 - air permeability

Appendix 3. Size-o-scope test

Table 5. Results from the Size-o-scope test, time needed for luminance to drop 1% and luminance measured at 300 seconds

	uncoated	G3%MCC	G4%MCC	F3%MCC	F4%MCC	G4%NCC	F4%NCC
1% - time/s*	57,6	32,4	34,6	28,4	25,2	28,6	324,2***
luminance at 300s**	91,2	93,5	93,6	93,4	92,1	92,5	99,2
1% - time/s	49,8	23,6	32,8	29,6	23,4	31,6	18,4
luminance at 300s	82,5	92,8	93,2	93,1	93,1	94,8	90,5
1% - time/s	62,6	25,4	27,8	28,4	28,6	33,4	24
luminance at 300s	91,1	92,4	93,1	93,3	92,9	94,9	88,5
luminance at 300s – average	88,27	92,9	93,3	93,27	92,7	94,07	92,73
1% - time/s average	56,67	27,13	31,73	28,8	25,73	31,2	122,2
*time needed for luminance to drop for 1%							
**luminance measured at 300 seconds							
*** readings for this sample were too high to it was not included in analysis							

Appendix 3. Ink transfer test, contrast density

Table 6. Results of the ink transfer test, contrast density and ink transfer value

	uncoated	G3%MCC	G4%MCC	F3%MCC	F4%MCC	G4%NCC	F4%NCC
average density	0,378	0,274	0,229	0,298	0,238	0,482	0,379
weight (ml-m ²)	0,0063	0,0044	0,0043	0,0055	0,0048	0,0061	0,00495
*10 ⁻²	0,63	0,44	0,43	0,55	0,48	0,61	0,495
ink transfer	0,589	0,411	0,405	0,517	0,452	0,570	0,463

Appendix 4. Wet repellence test, for both water amounts applied

Table 7: Wet repellence test with less water applied

0.5ml/m ² water	uncoated	G3%MCC	G4%MCC	F3%MCC	F4%MCC	G4%NCC	F4%NCC
density							
not damped, only printed	1,12	1,19	0,92	1,25	1,23	1,34	1,36
damped and printed	1,08	1,09	0,78	1,11	1,13	0,81	0,73
same as A	1,21	1,13	0,95	1,14	1,14	1,19	1,21
same as B	1,25	1,16	0,96	1,18	1,19	1,37	1,43
Wet pick + wet repellence	3,74	8,20	15,27	11,16	8,75	39,84	46,46
Wet pick	-3,65	-2,24	-1,05	-3,16	-4,39	-14,52	-18,32
Wet repellence	7,39	10,44	16,32	14,32	13,15	54,39	64,79

Table 8: Wet repellence test with more water applied

1.35 ml/m ² water	uncoated	G3%MCC	G4%MCC	F3%MCC	F4%MCC	G4%NCC	F4%NCC
density							
not damped, only printed	0,96	1,24	1,20	1,24	1,10	1,36	1,33
damped and printed	0,86	0,46	0,46	0,44	0,27	0,63	0,35
same as A	1,12	1,14	1,15	1,18	1,12	1,21	1,24
same as B	1,22	1,49	1,44	1,53	1,55	1,44	1,55
Wet pick + wet repellence	9,81	63,13	61,87	64,84	75,51	53,93	73,83
Wet pick	-9,12	-31,83	-24,87	-30,14	-37,64	-19,21	18,01
Wet repellence	18,93	94,96	86,74	94,98	113,15	73,14	55,83

Appendix 5. Abbreviations used in this thesis

Abbreviations	Explanation
NC	Nanocellulose
NCC	nanocrystalline cellulose
CNC	cellulose nanocrystals
TEMPO oxidation	2,2,6,6-Tetramethylpiperidinyloxy
MCC	Microcrystalline cellulose
DP	degree of polymerization
LODP	level-off degree of polymerization
db	dry basis
w/w or wt. %	Weight/weight %
SDTA	Short dwell time applicator
LWC	Light weight coating
IR	Infrared
rh	Relative humidity